

SNAP SHIPS®

BUILD TO BATTLE®

HAMMERJAW

K.L.A.W.
CARRIER GUNSHIP
BUILD #1 - P. 4

K.L.A.W.
CLOSE SUPPORT
BUILD #2 - P. 30

K.L.A.W.
AWACS ORNITHOPTER
BUILD #3 - P. 52





Download
the Snap Ships
app for
interactive
builds
and play

THE THREAT TO HUMANITY CONTINUES...

The brutal aliens of the Komplex are still spreading through the galaxy in an attempt to defeat and assimilate all other species. The elite team of the Forge is humanity's last line of defense against the enemy threat.

With the versatile, modular spacecrafts known as Snap Ships, both the Komplex and Forge have an armada of attack crafts, bombers, drones, mechs and more to configure and reconfigure to optimize their strengths in the fight to survive.

Now that you are part of the Snap Ships universe, how will you

►► **BUILD TO BATTLE?!** ◀◀

THE MYSTERY OF UJU TECH

An ancient civilization, UJU KON, has left behind their advanced technology. The Forge and Komplex find and collect these tech pieces to add to their Snap Ships for more power and unheard-of abilities. Unlike the modular Snap Ship parts, UJU tech is a flexible material for more creative connections.

Watch Action-Packed Videos!



HAMMERJAW K.L.A.W. CARRIER GUNSHIP

Hammerjaw can turn the tide of a planet-side attack. Though heavily armed with missiles and guns, its real power comes from the two assault drones it can deploy. Dropped at a low altitude, the drones can speed along quickly firing laser cannons. Its features include:

- **K-WHEEL SUPPRESSION MECHS**, high-speed autonomous drones
- **CBW-3 HEAVY BEAM WEAPON**, a high trajectory mortar cannon
- **KINETIC SHIELDING** swivel mount beam cannon



PILOT



This ship is piloted by a Complex Pilot.

WHICH UJU TECH WILL YOU FIND?

There are four powerful UJU tech pieces for you to find—how will you use them to maximize your ship's capabilities?

Are you ready to **BUILD TO BATTLE?**

Includes: 93 Building Pieces, 4 Accessories, 8 Projectiles, Instructions.
Note every build will use every component—it's OK to leave some pieces in the hangar for later!

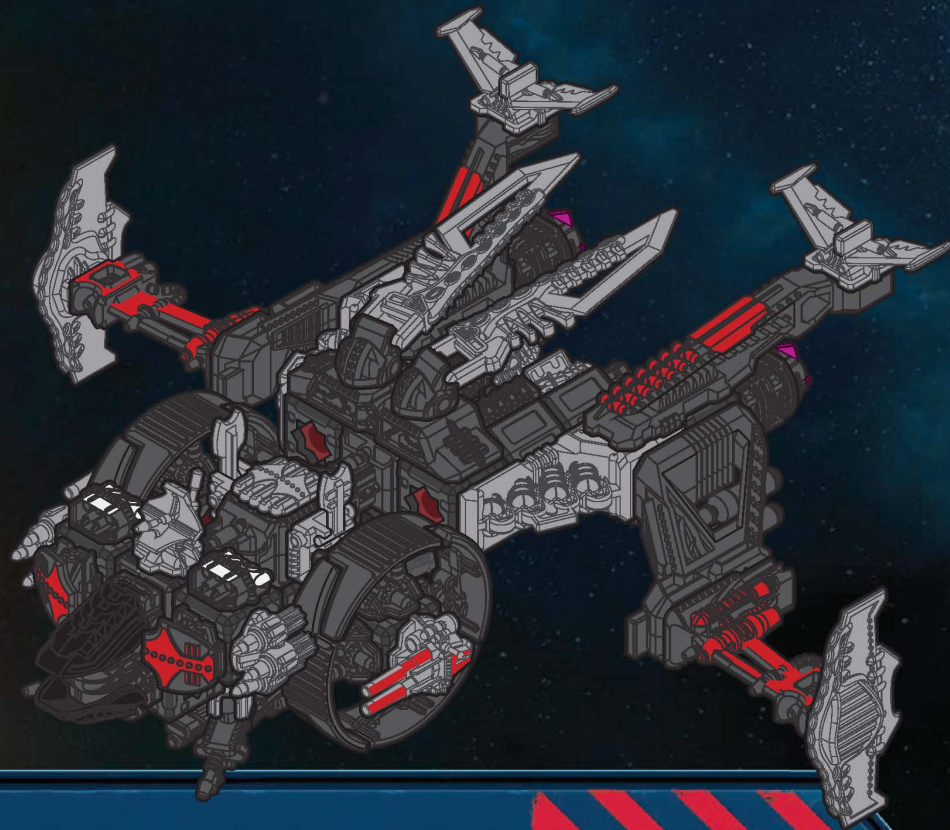

HAMMERJAW K.L.A.W.
CARRIER GUNSHIP

BUILD #1

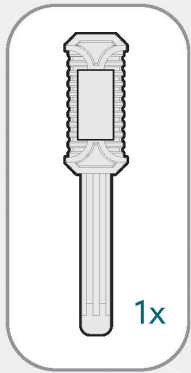

Separation Tool

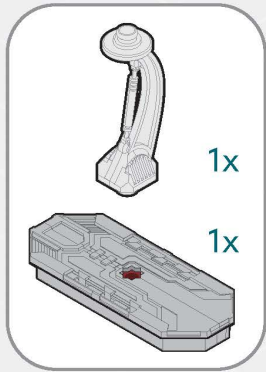
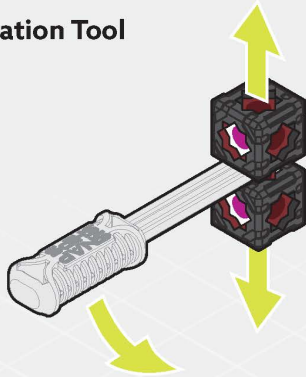

Box top is also a display stand

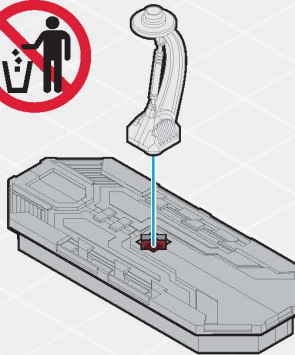

1

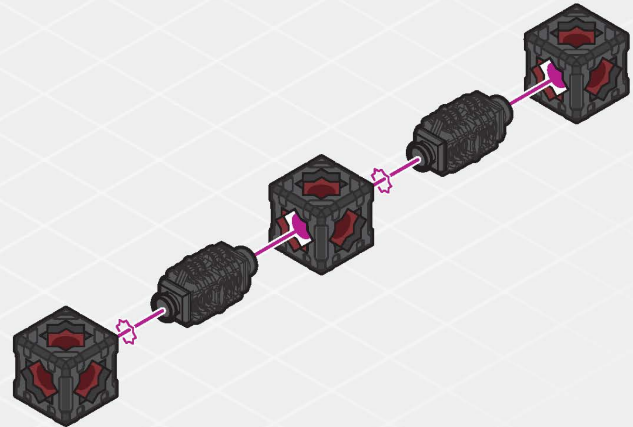
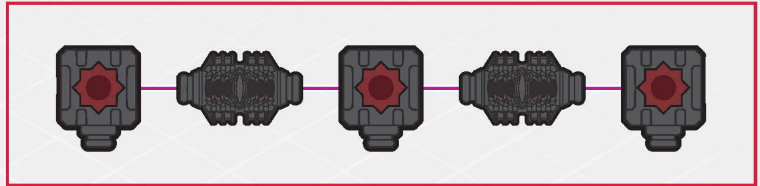
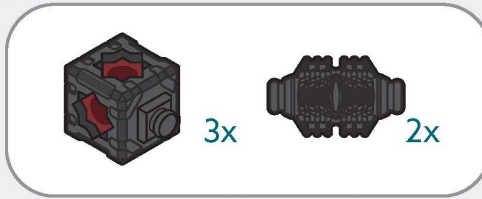

2

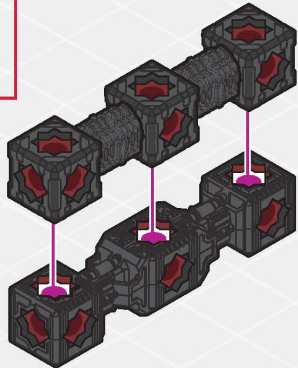
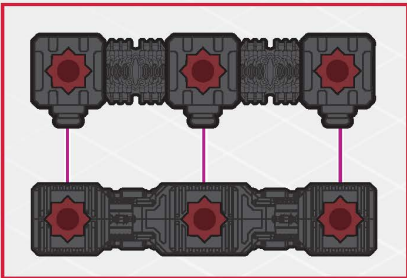
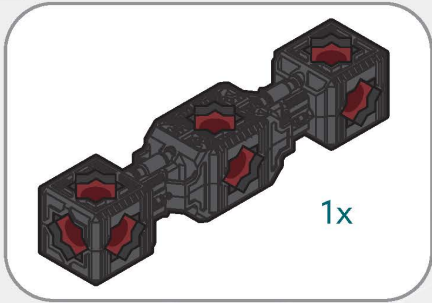

3

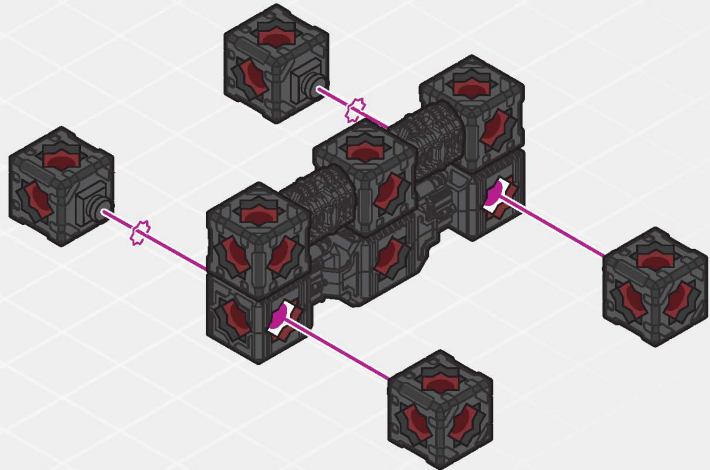

4

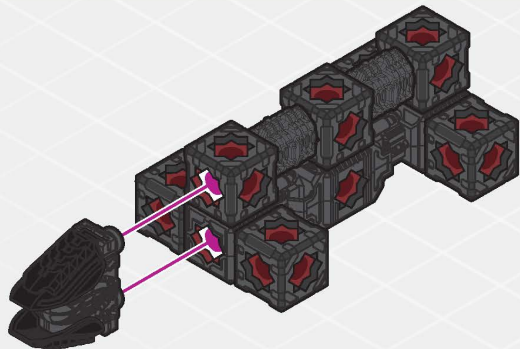
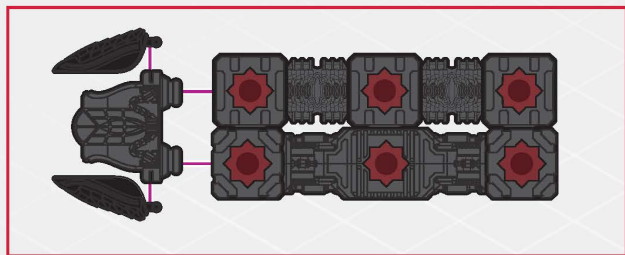
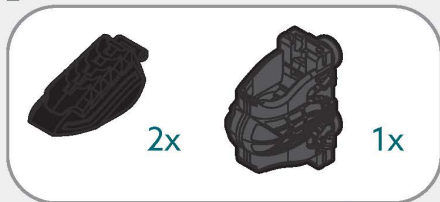

5

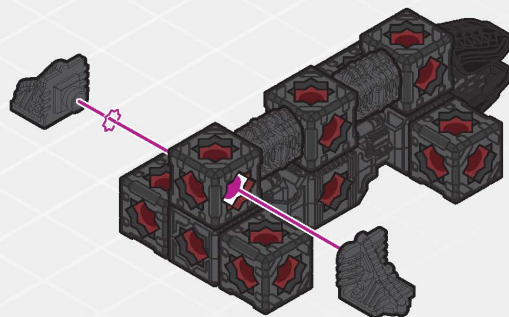
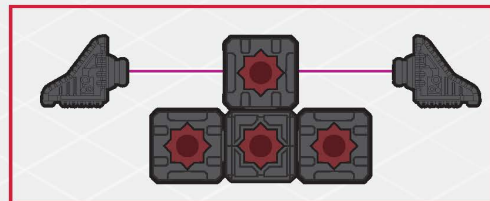
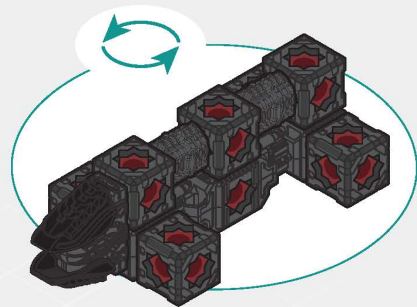

6

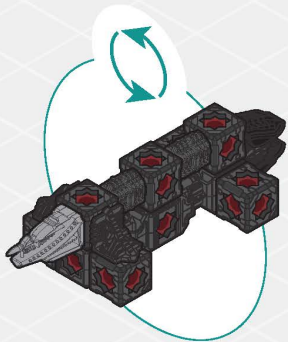
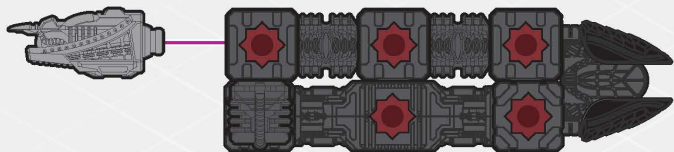

7

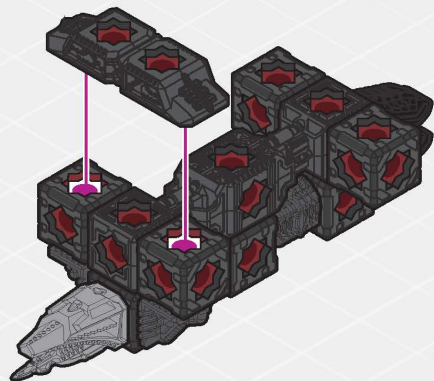
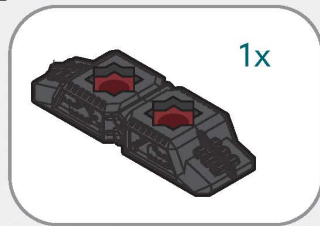

HAMMERJAW BUILD #1

8

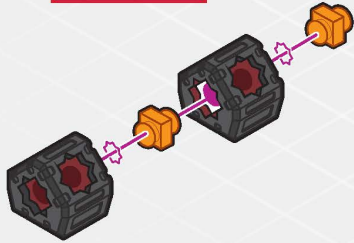
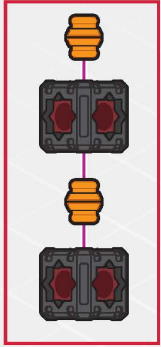

9

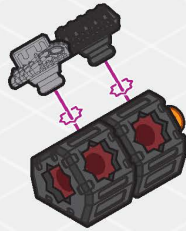
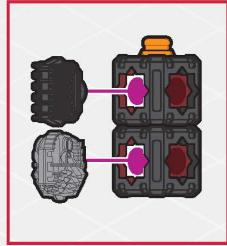

10

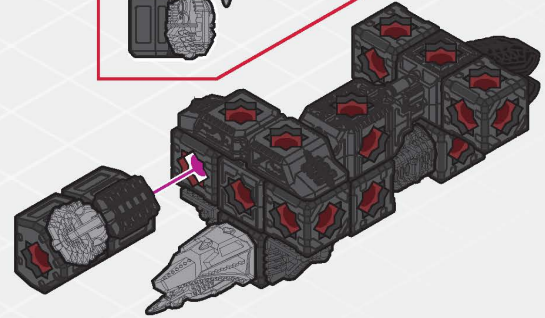
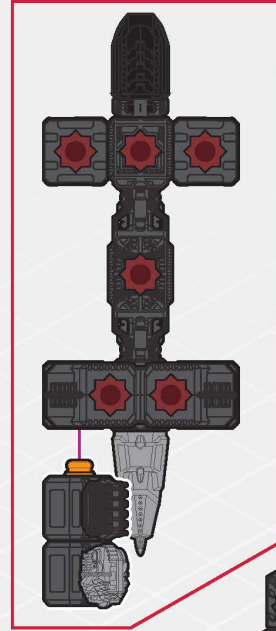

11

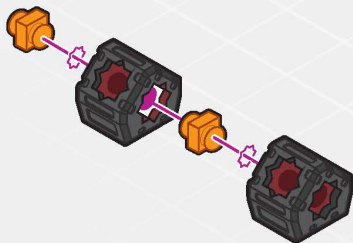
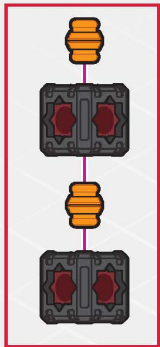

12

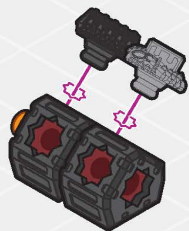
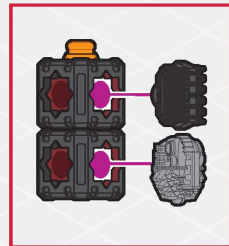

13

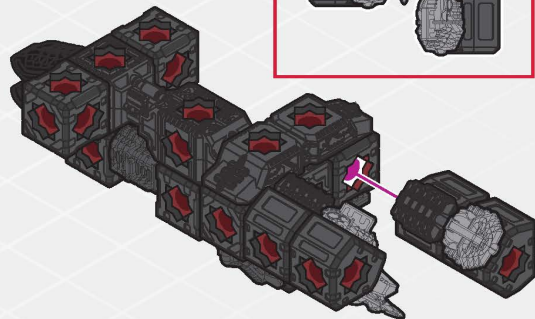
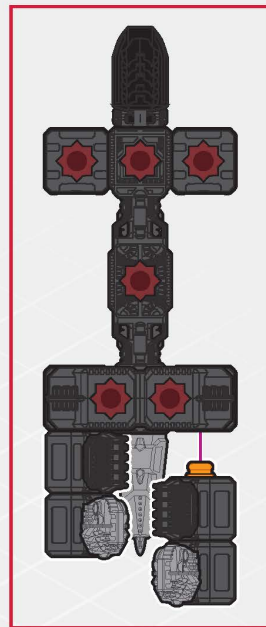

14

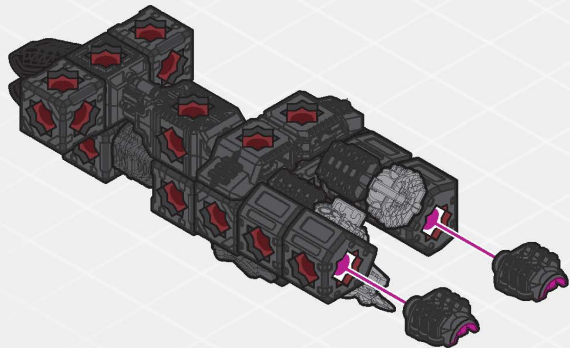
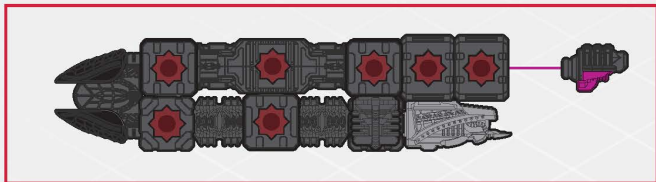

15

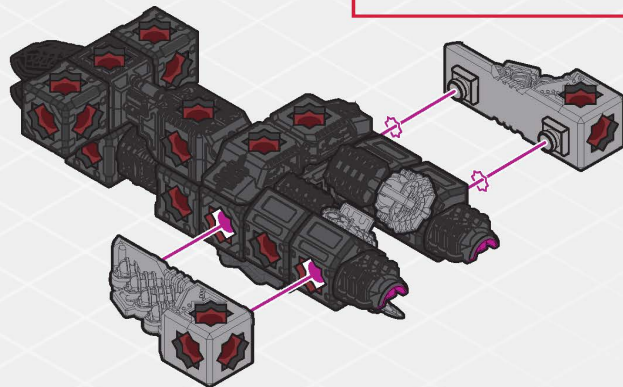
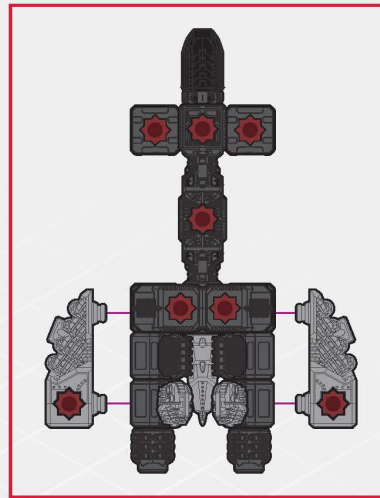
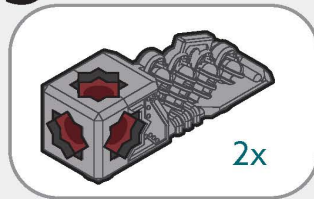

16



2x



2x



2x

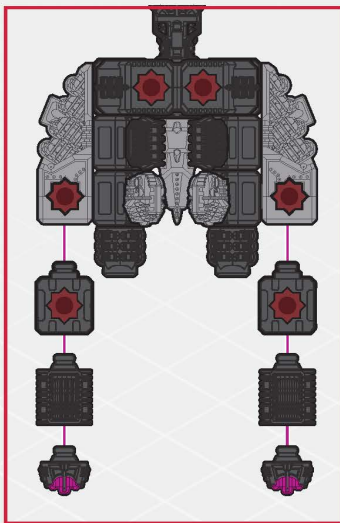

17



2x

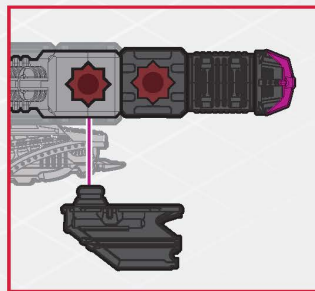
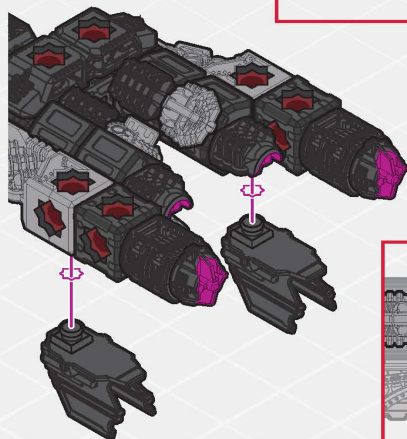
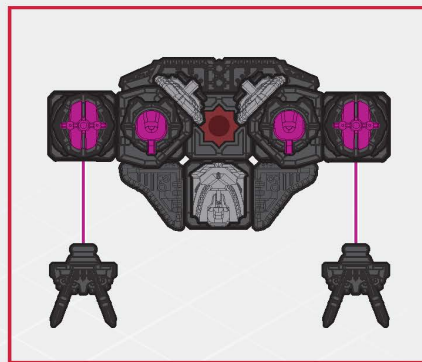

18

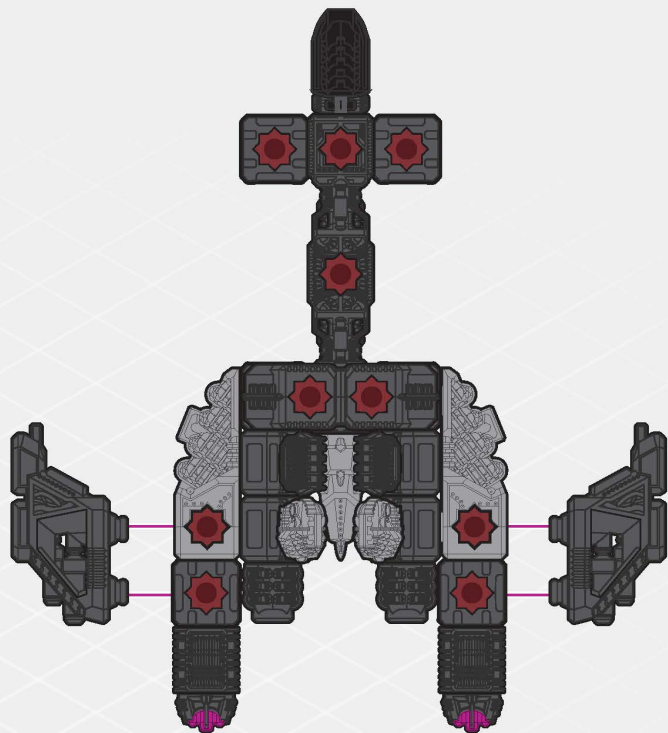
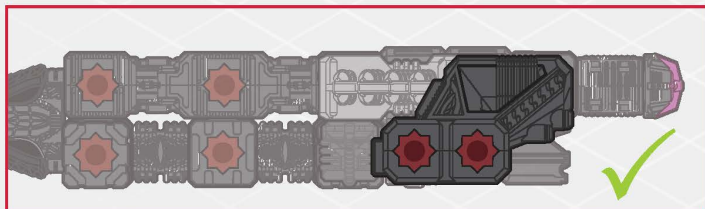
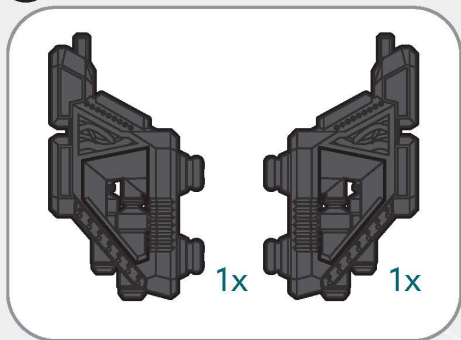

19

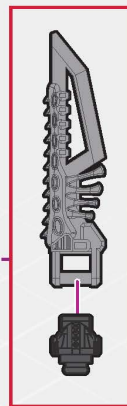
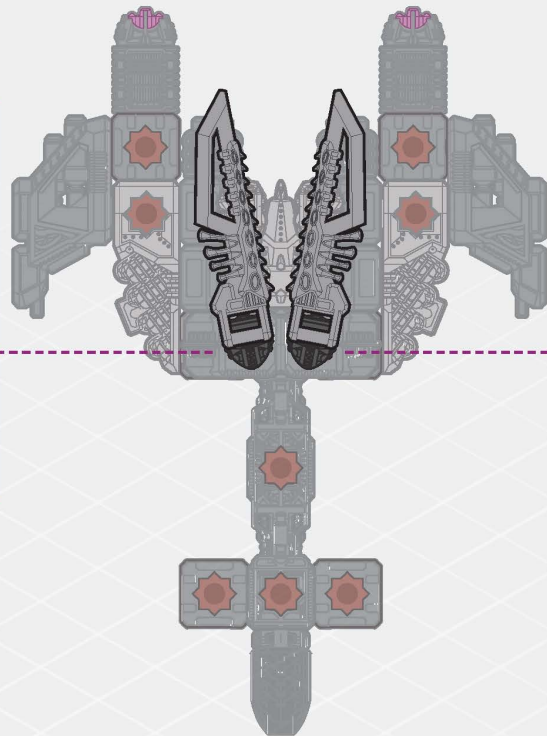
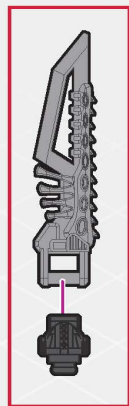
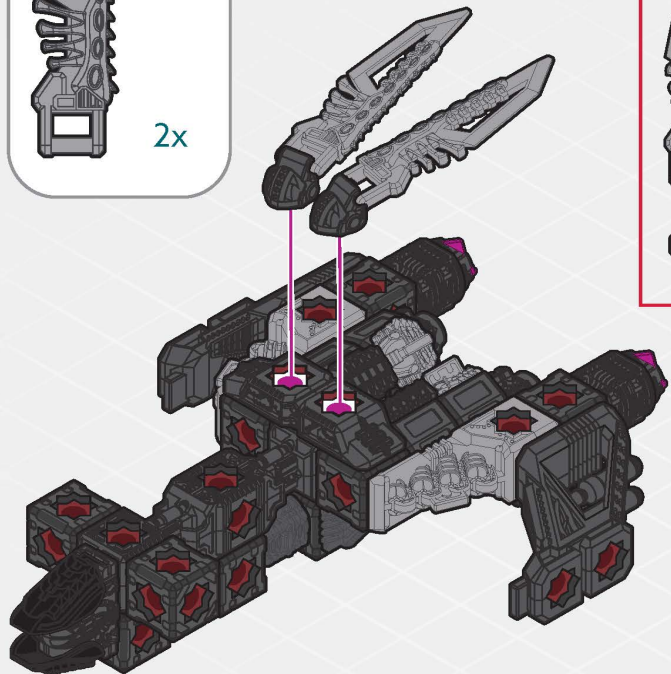
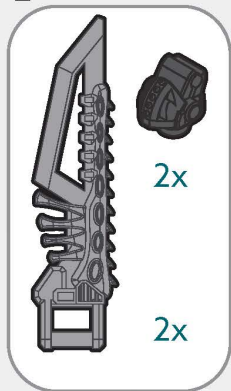

20

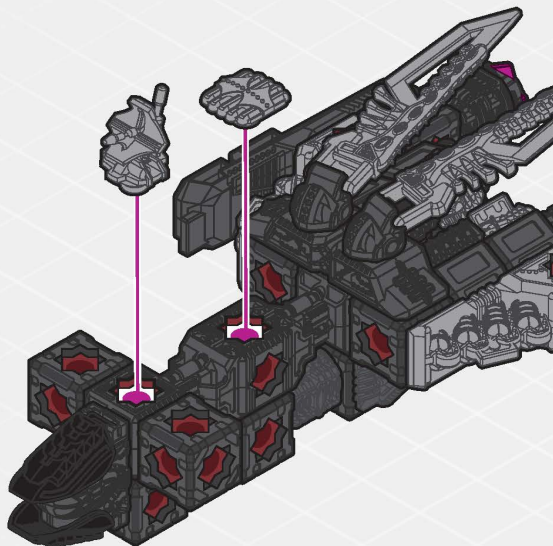
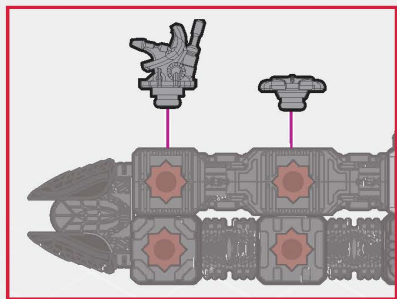

21

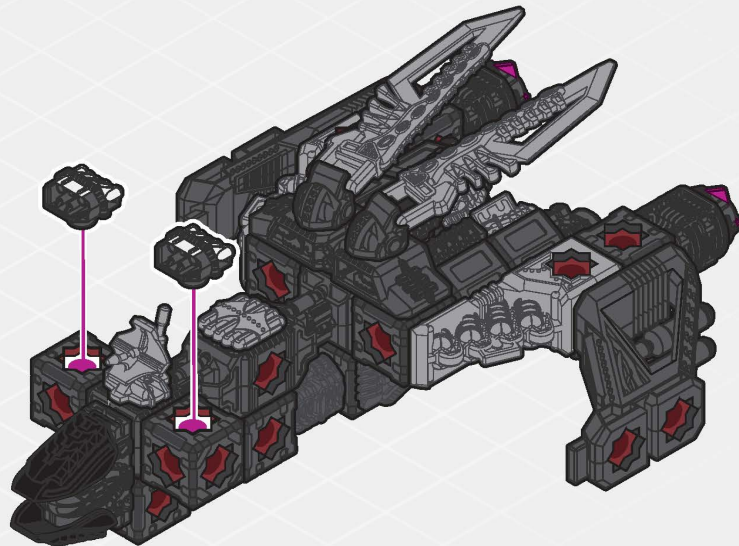
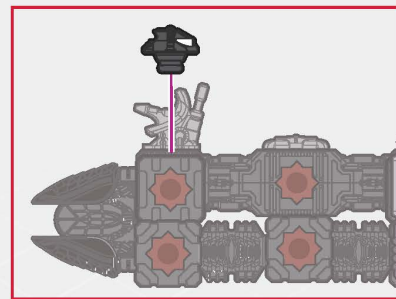

22

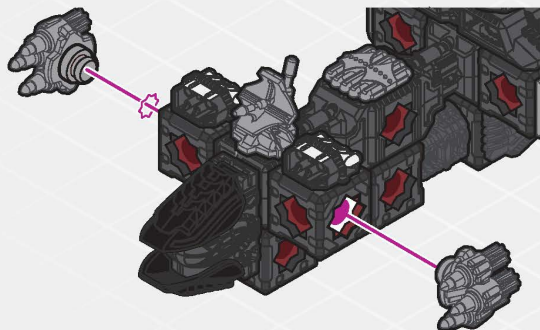
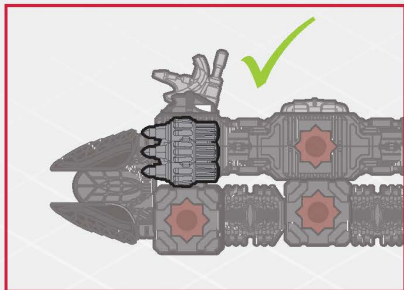

23

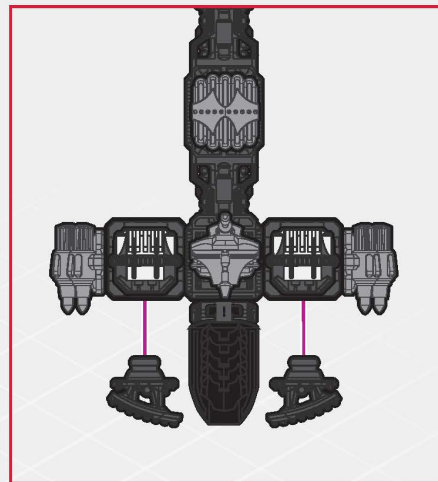
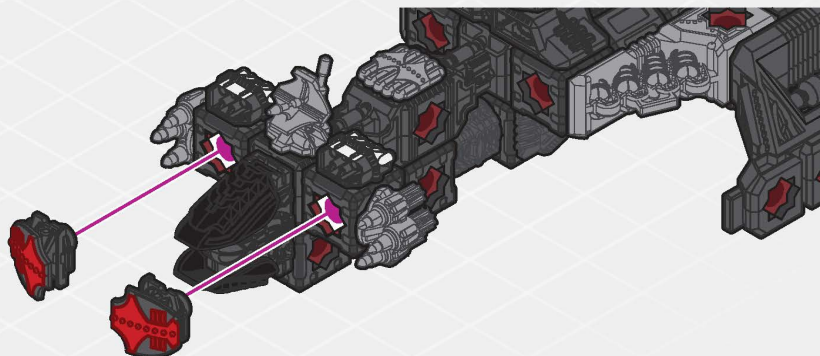
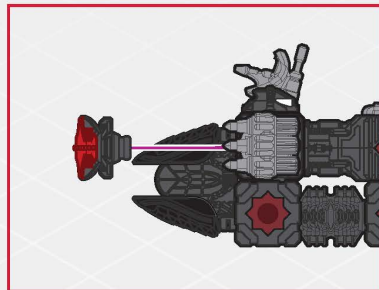

24

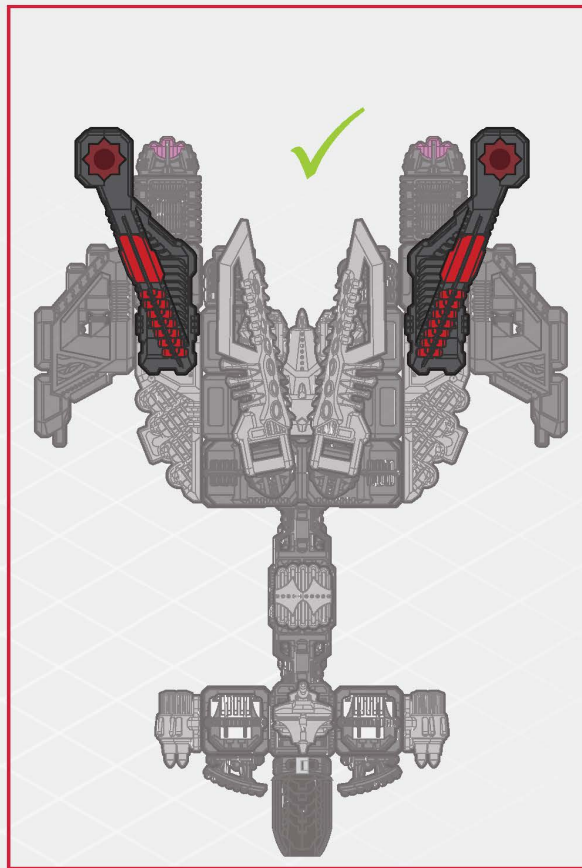
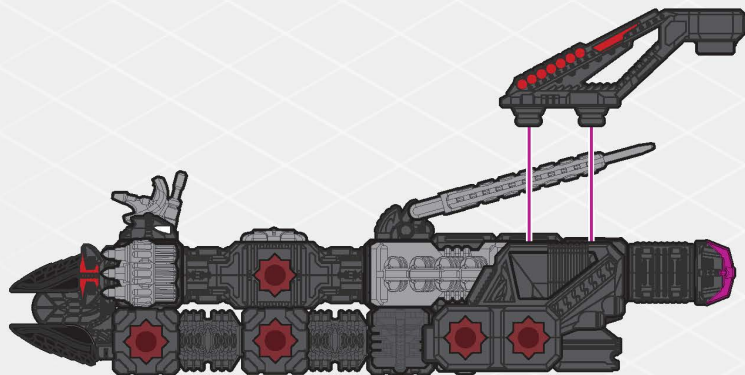
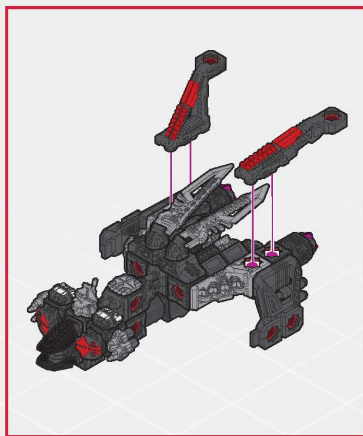
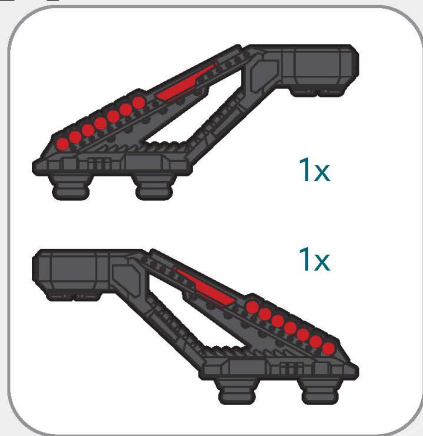

25

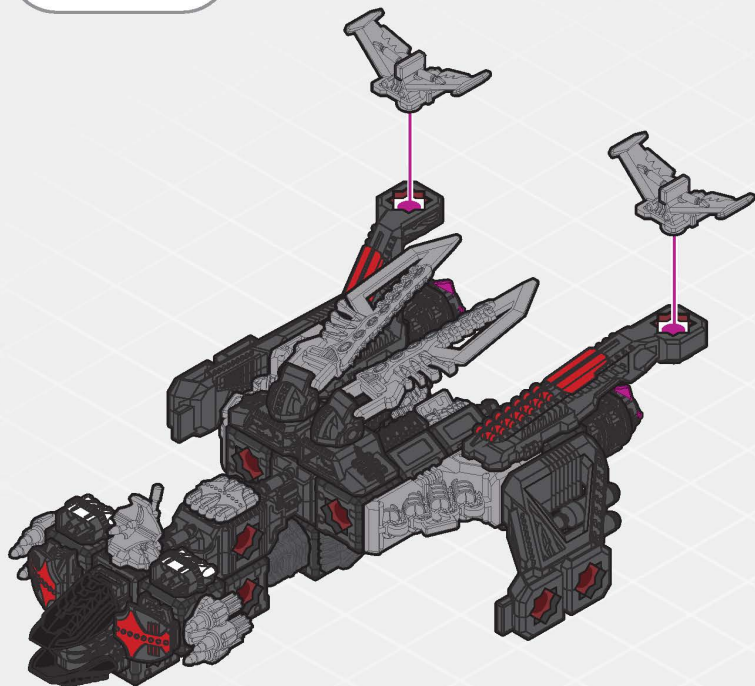
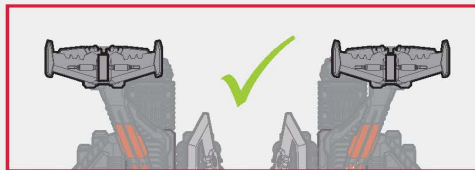

26

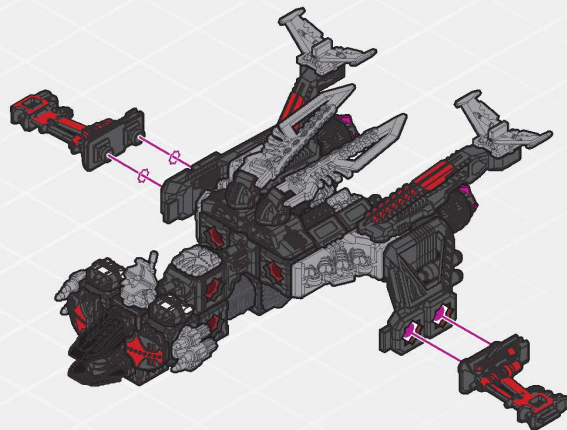
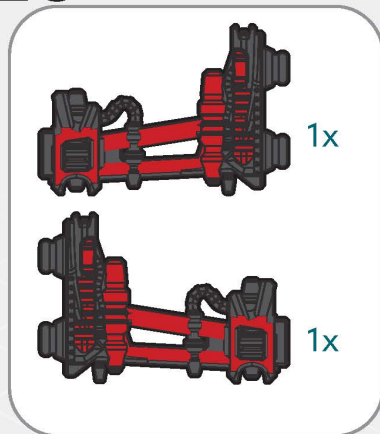

27

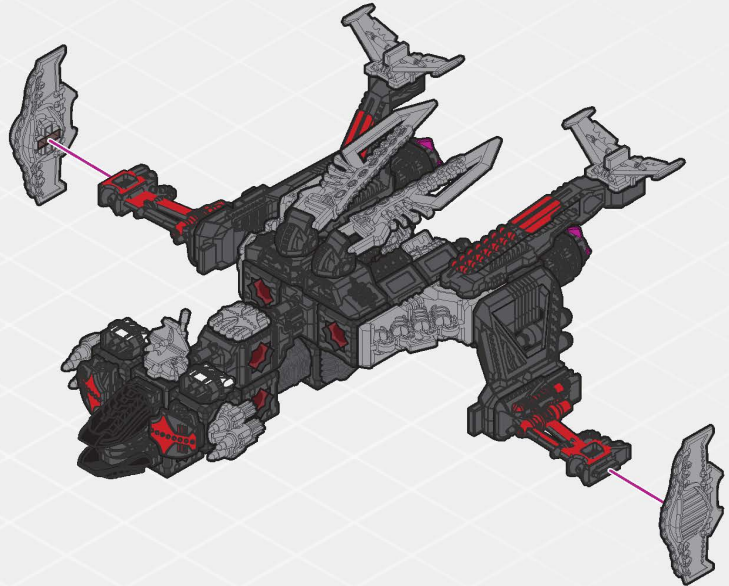
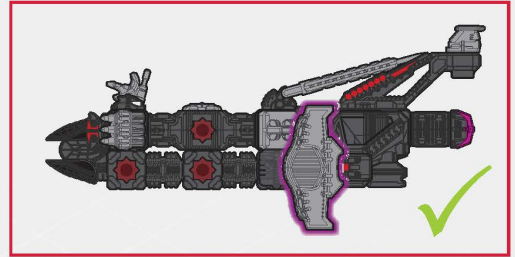
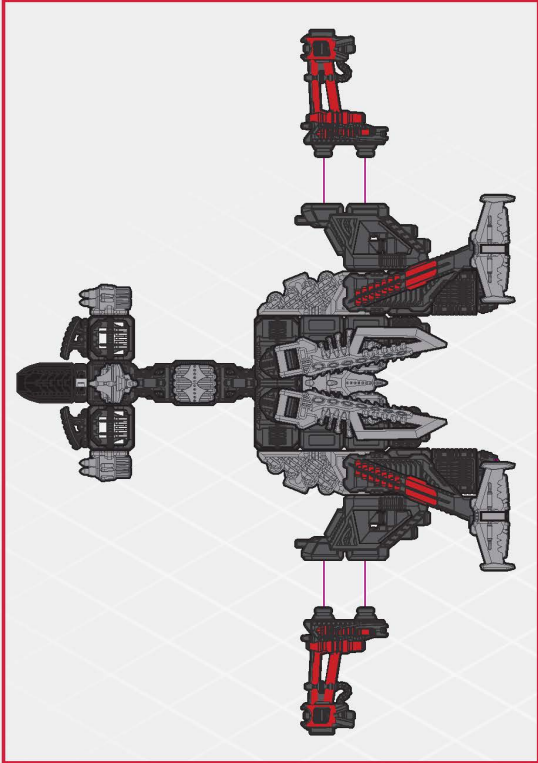

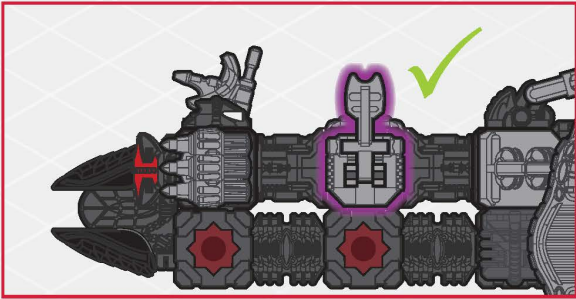
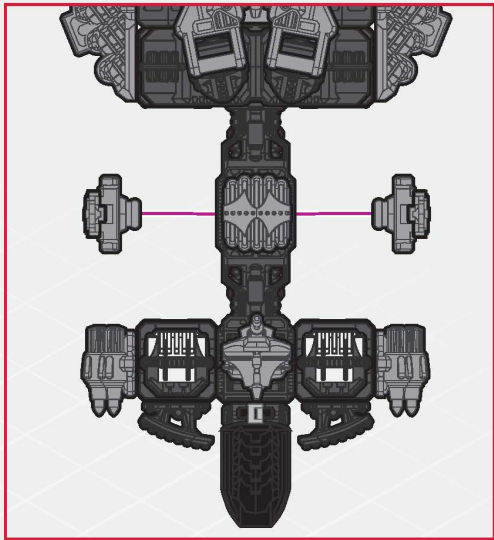
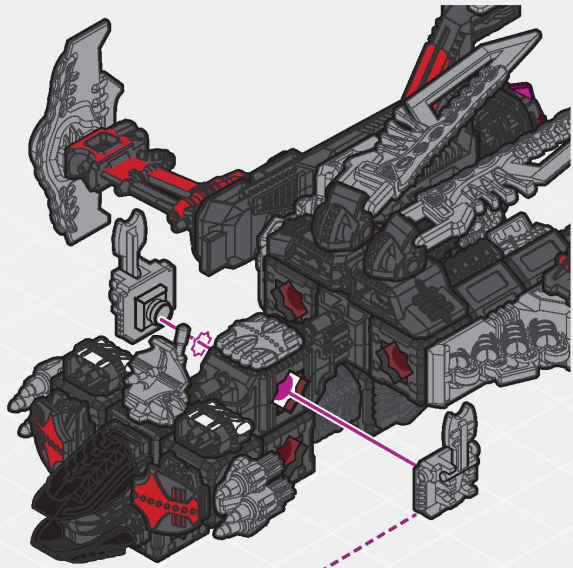
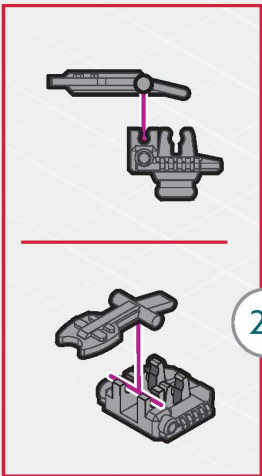
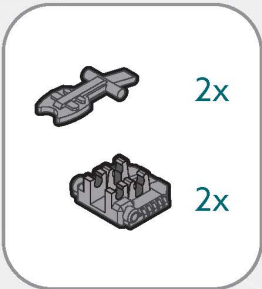

29

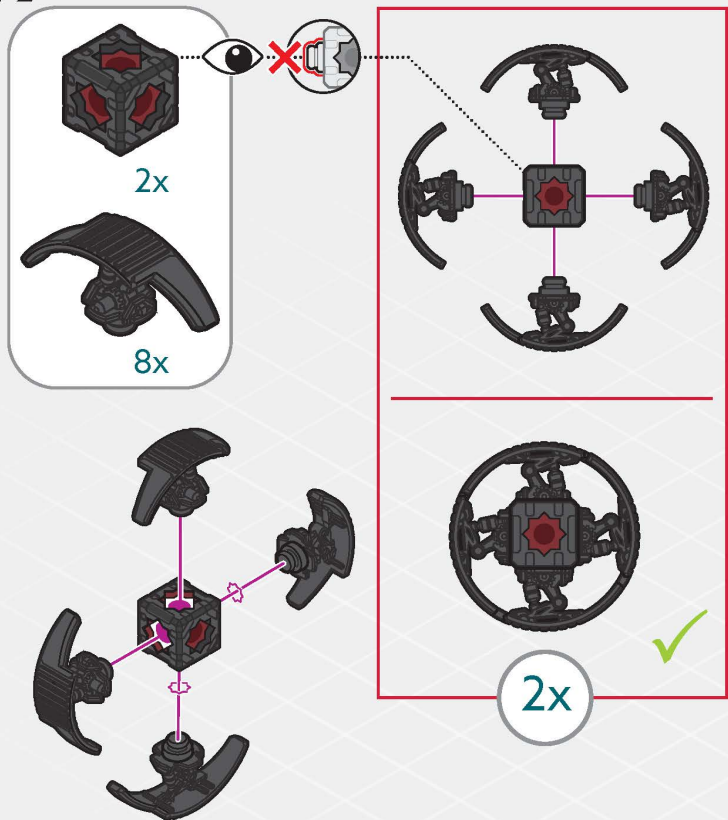

30

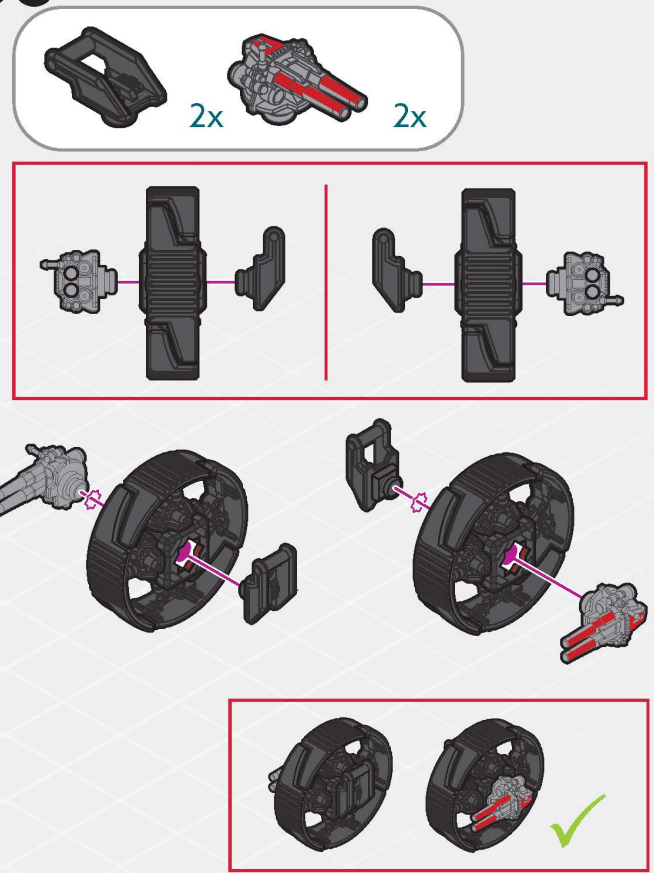

31

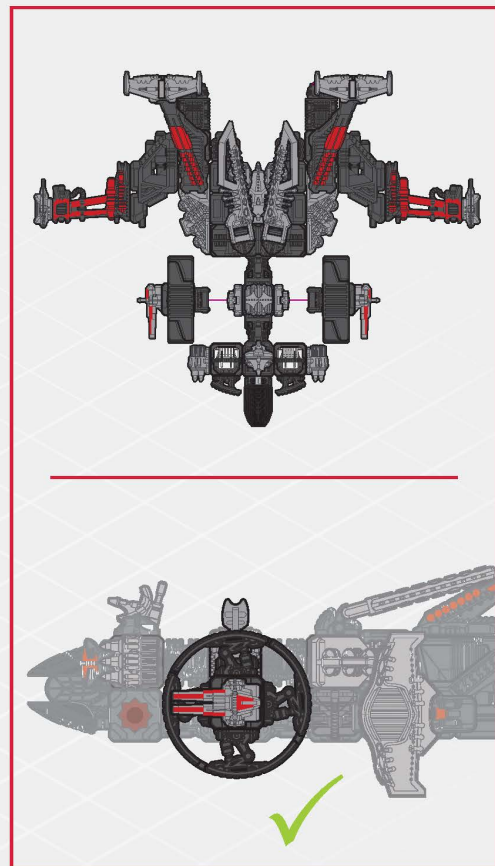
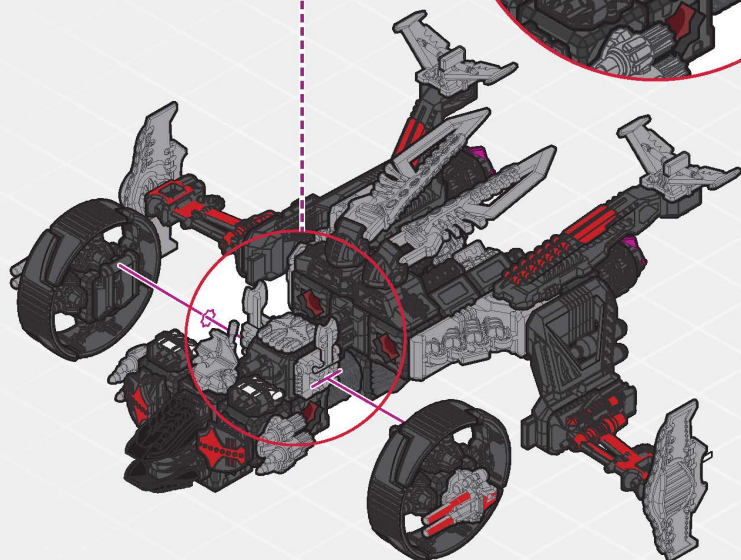
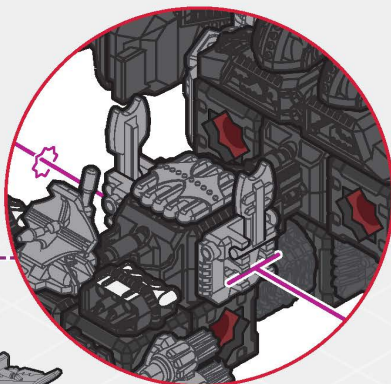
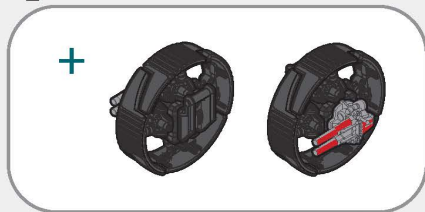

HAMMERJAW BUILD #1

32

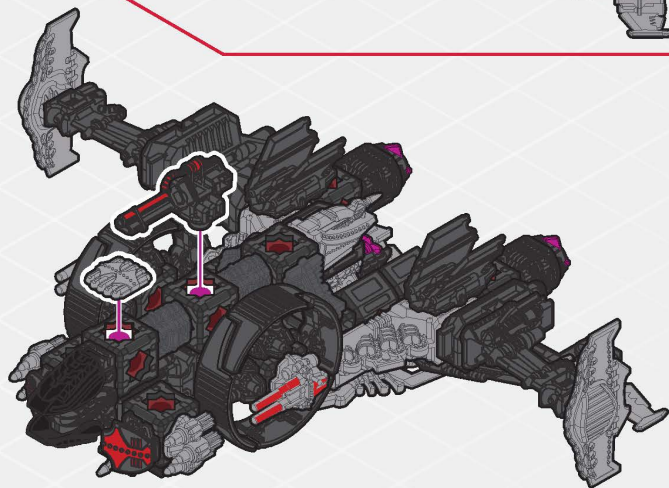
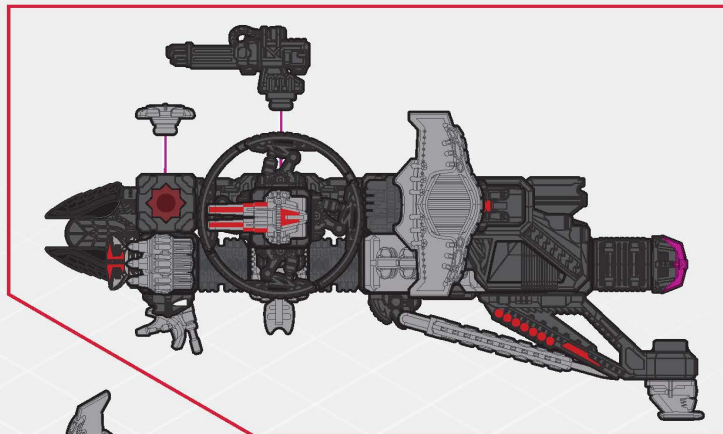
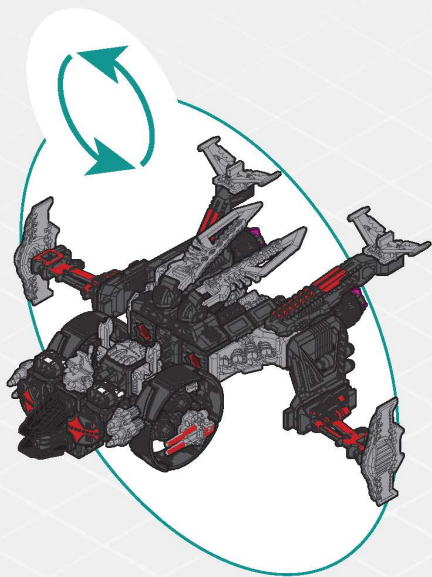
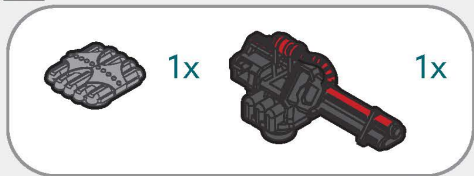

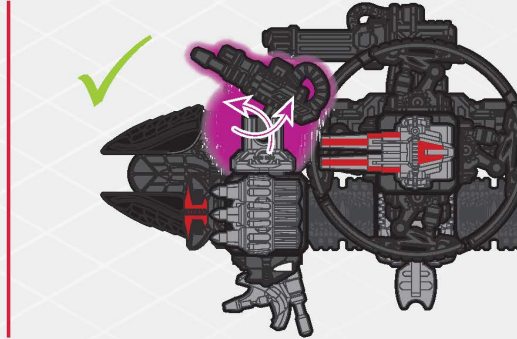
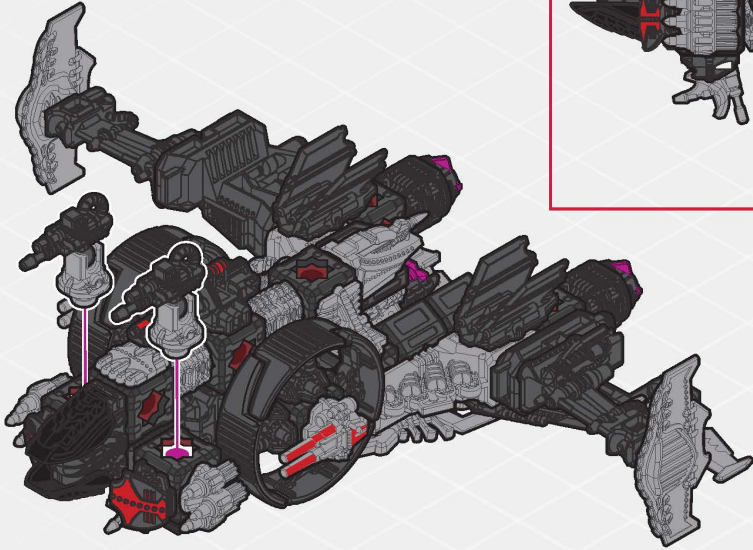
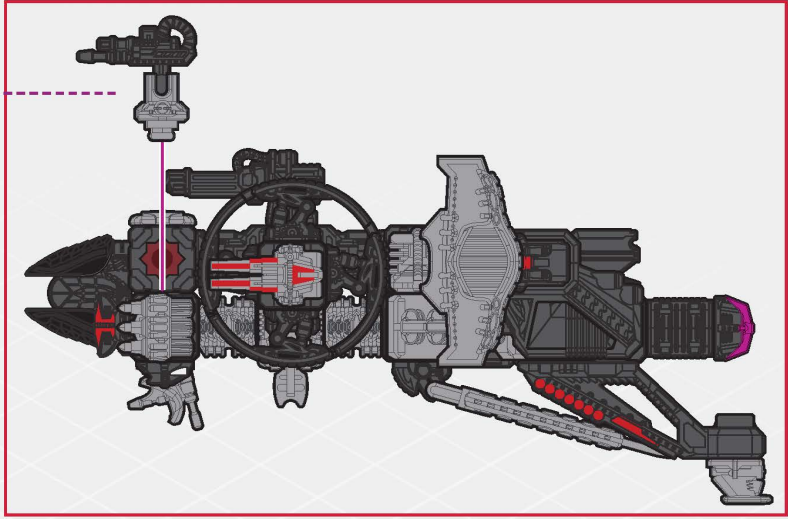
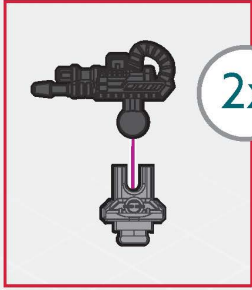
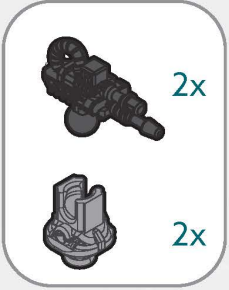

34

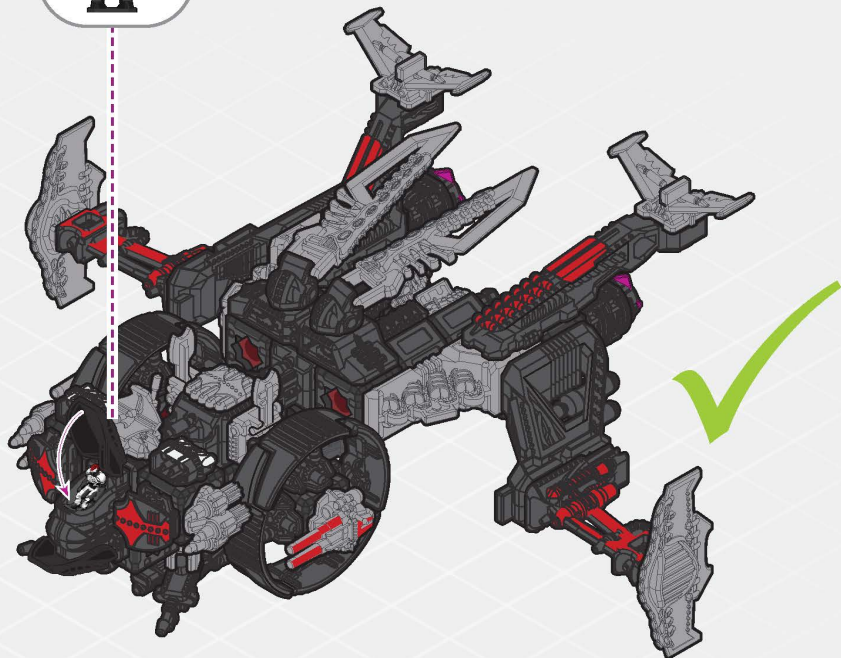
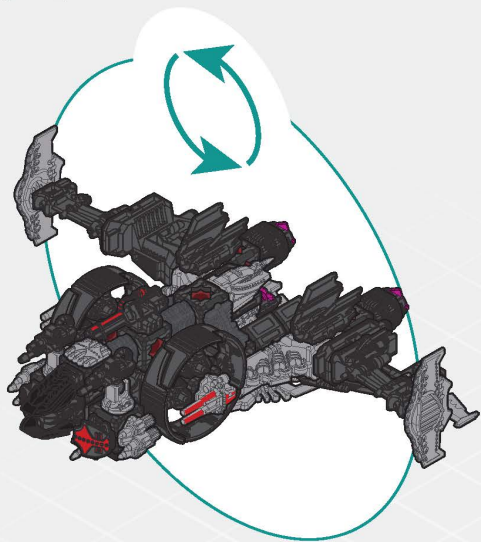

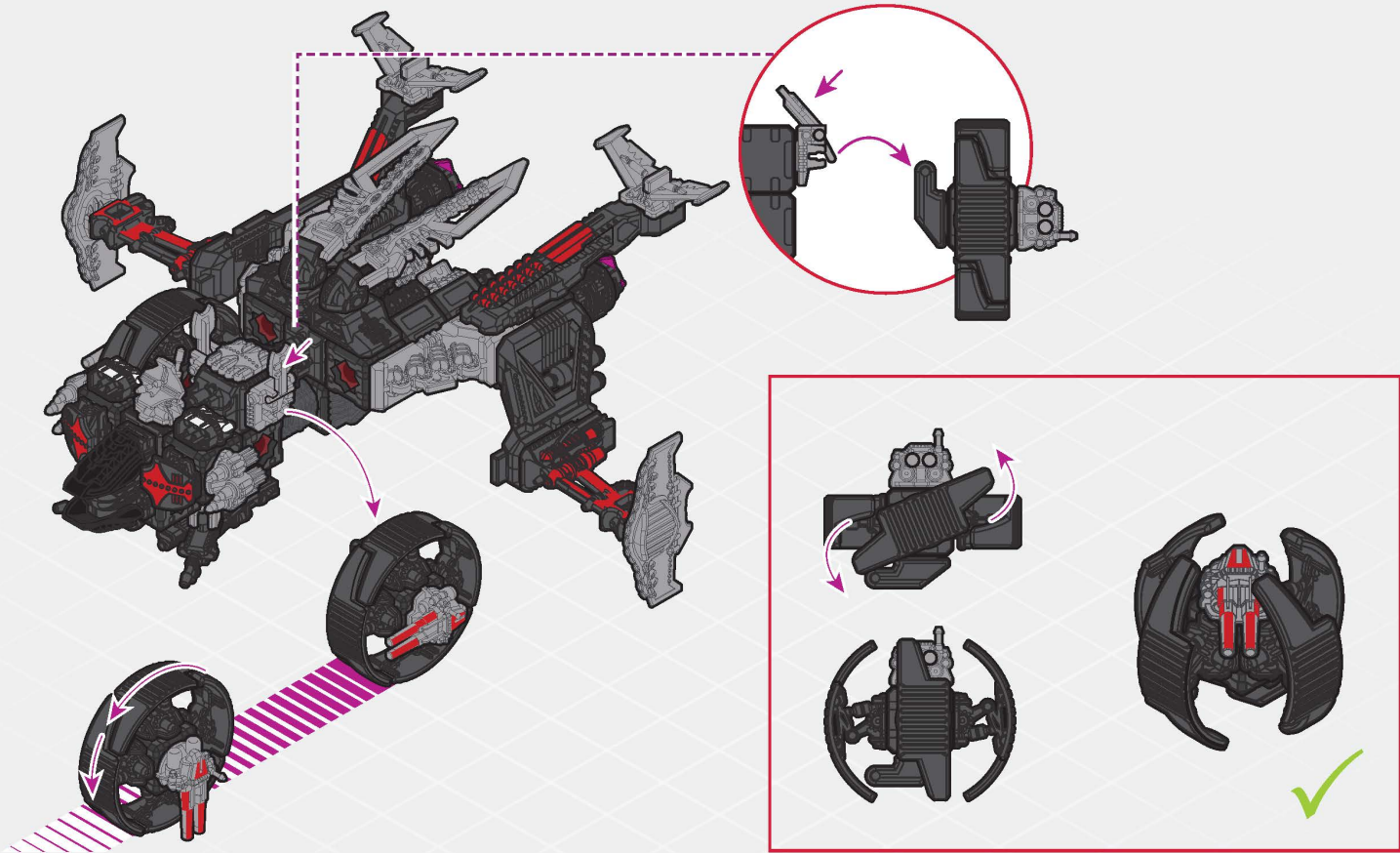

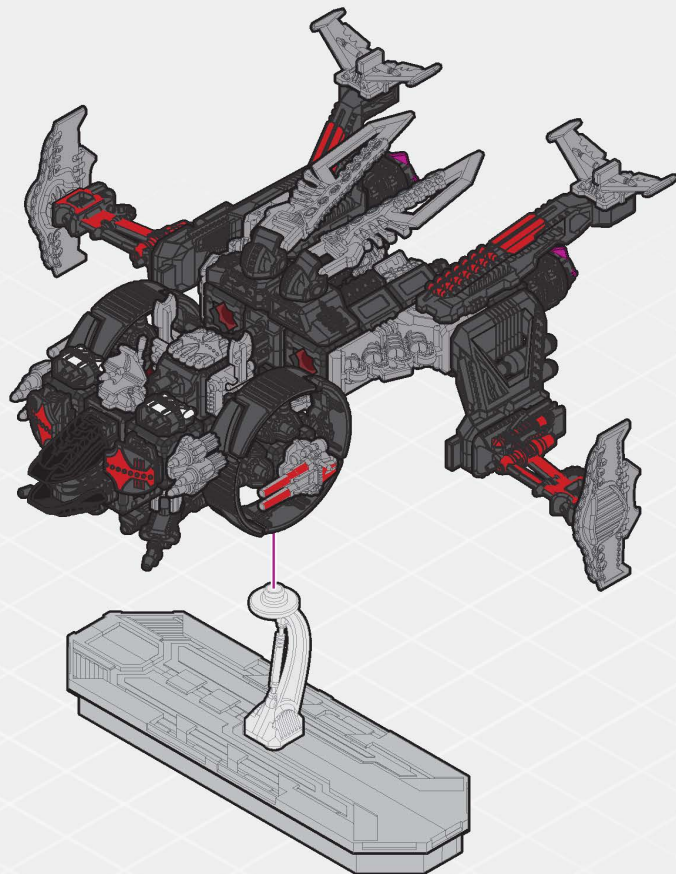
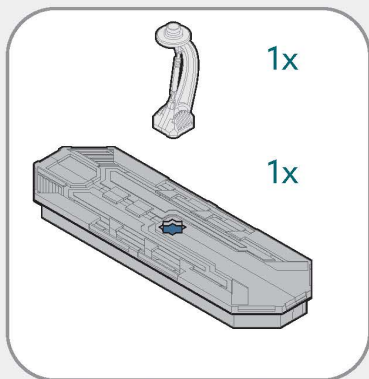

Continue searching for the rest when you collect more Snap Ships!

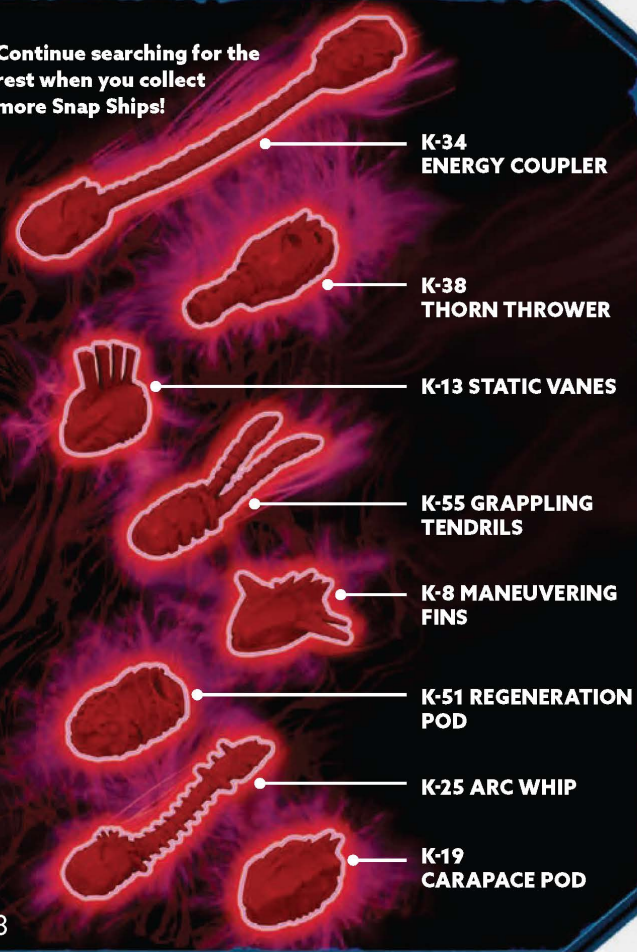

K-34
ENERGY COUPLER

K-38
THORN THROWER

K-13 STATIC VANES

K-55 GRAPPLING
TENDRILS

K-8 MANEUVERING
FINS

K-51 REGENERATION
POD

K-25 ARC WHIP

K-19
CARAPACE POD

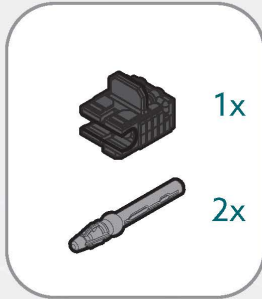

⚠ WARNING:
EYE IMPACT HAZARD— Do not aim at eyes or face.

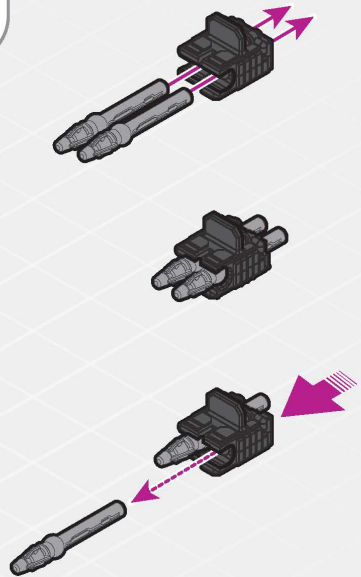

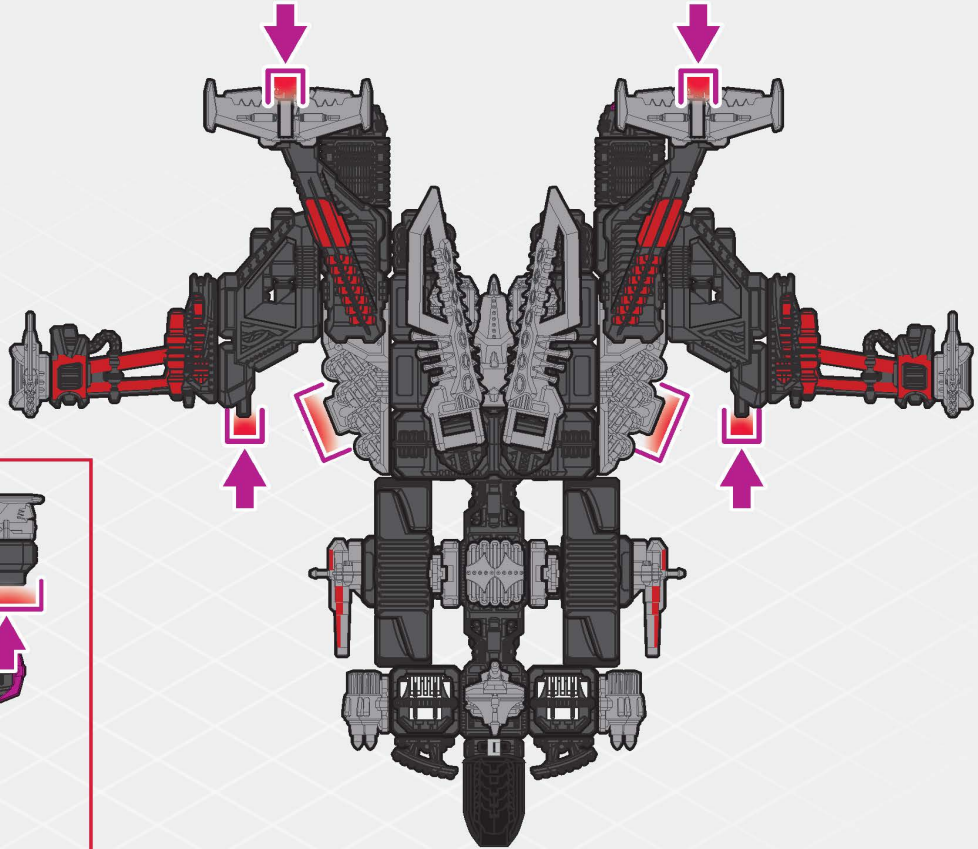
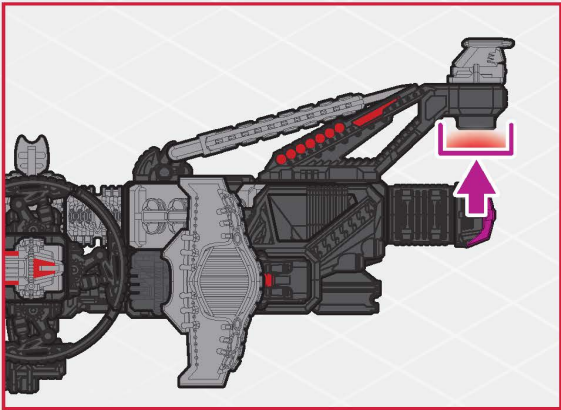

ACCESSORIES



HAMMERJAW

K.L.A.W.
CLOSE SUPPORT

BUILD #2

1

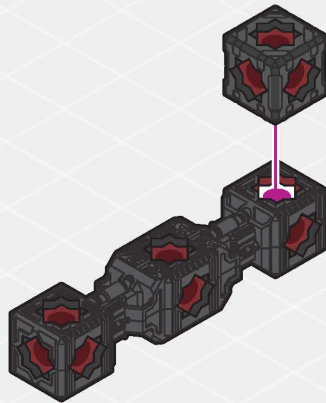
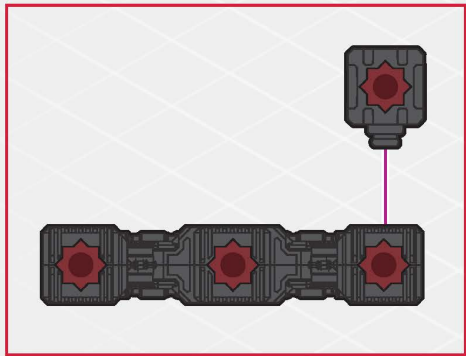
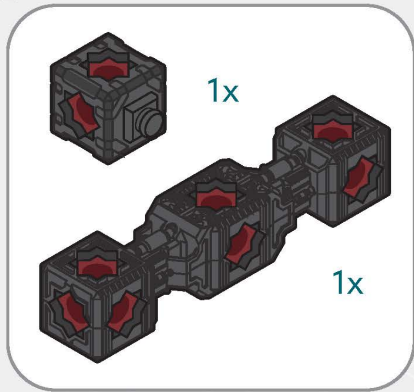

2

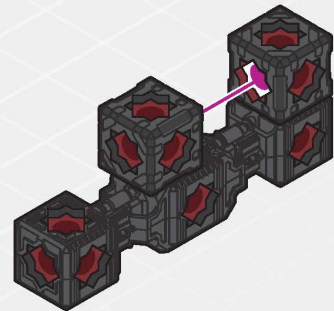
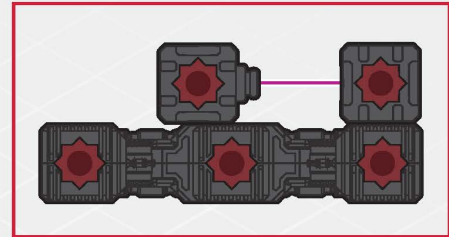

3

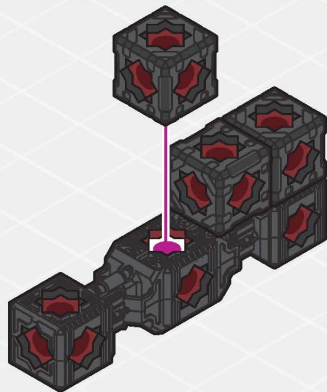
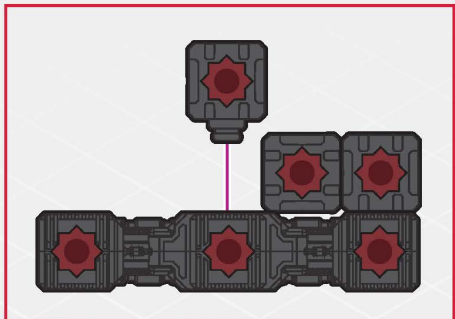

4

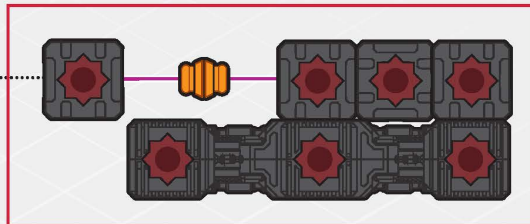

5

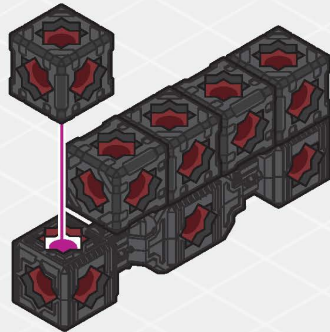
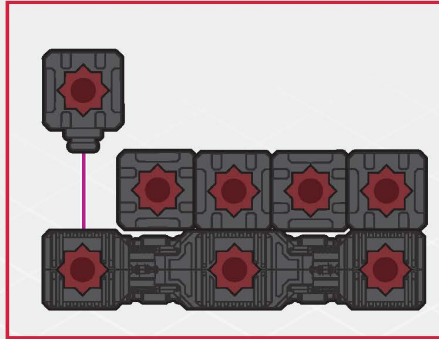

6

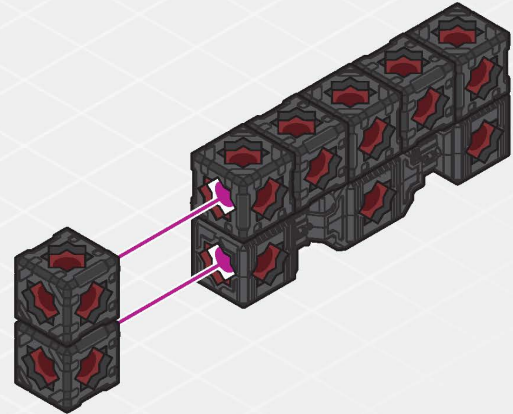
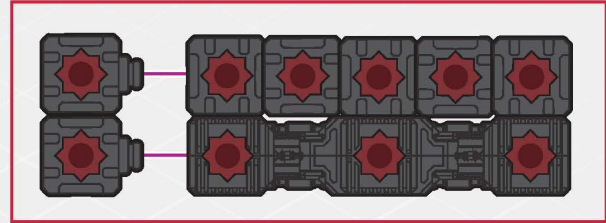

7

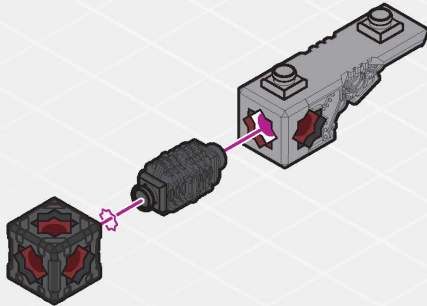
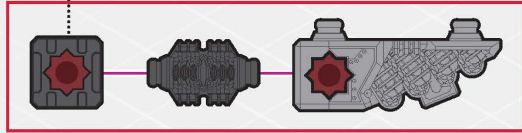
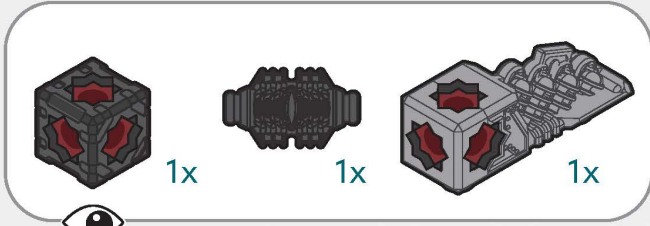

8

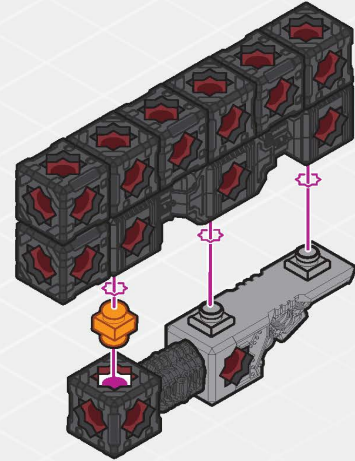
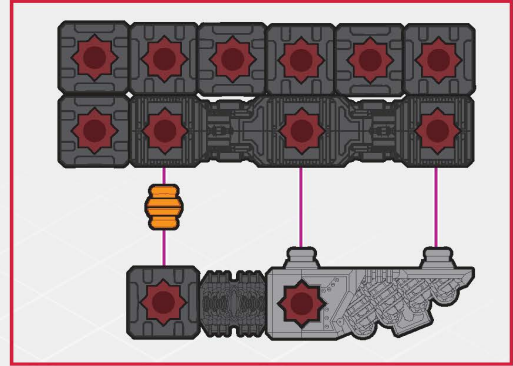

9

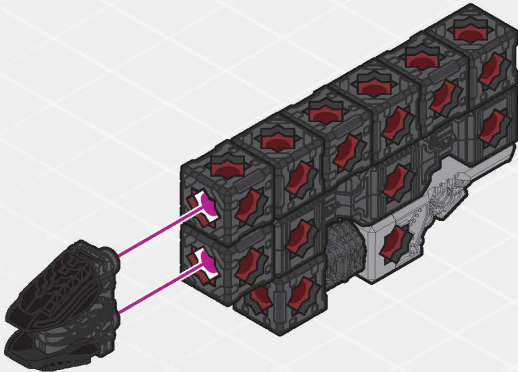
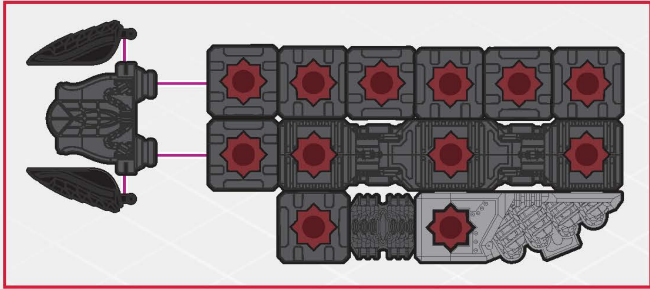
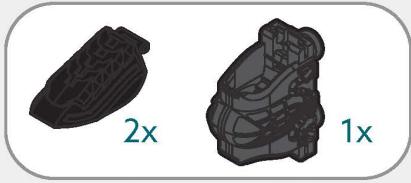

10

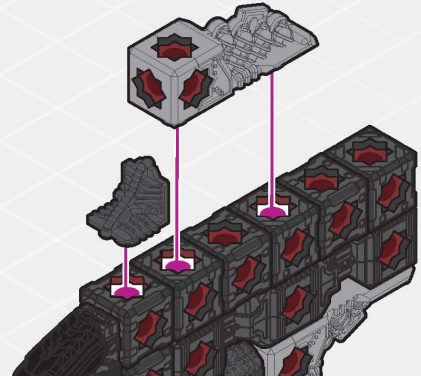
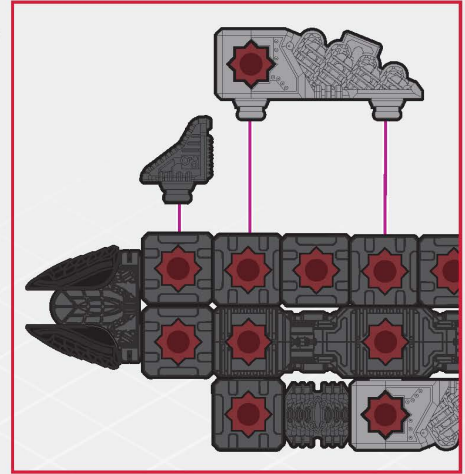
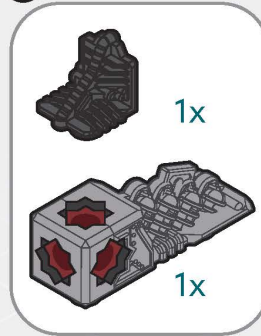

11

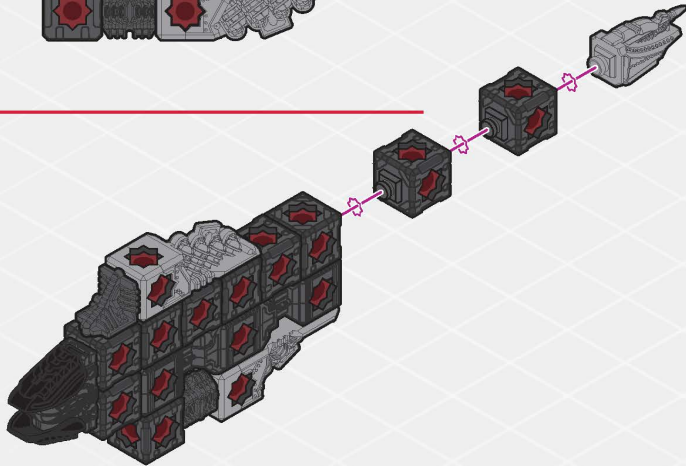
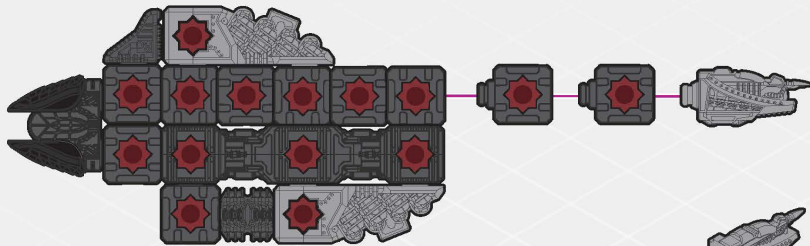
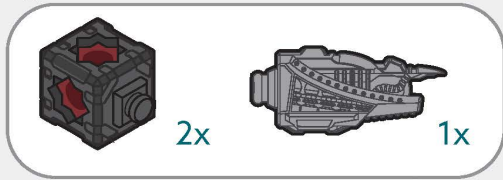

12

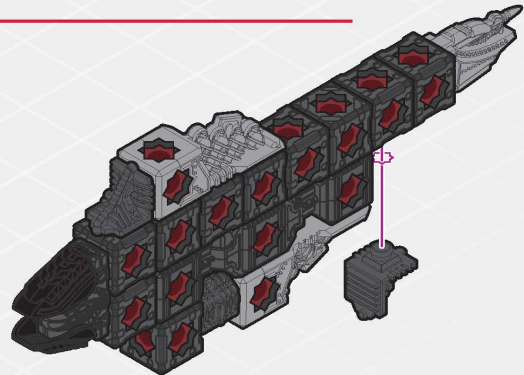
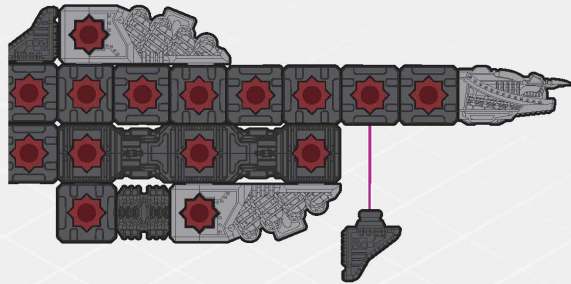

13

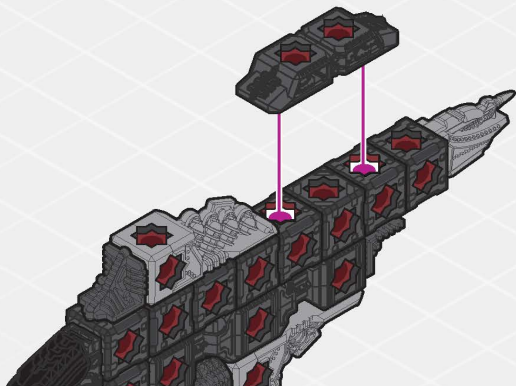
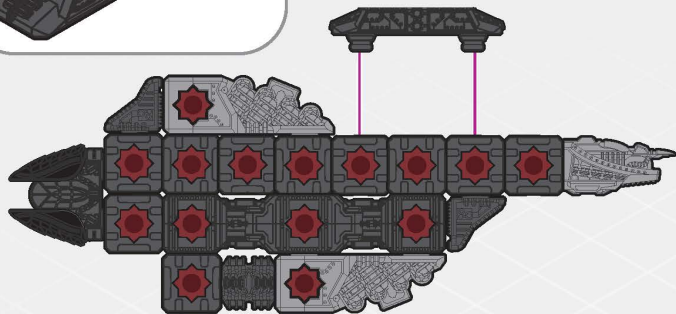
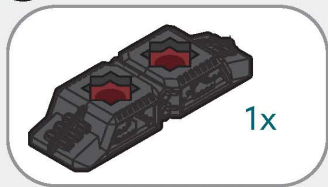

14

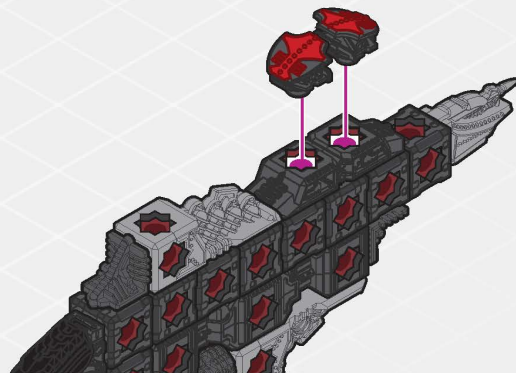
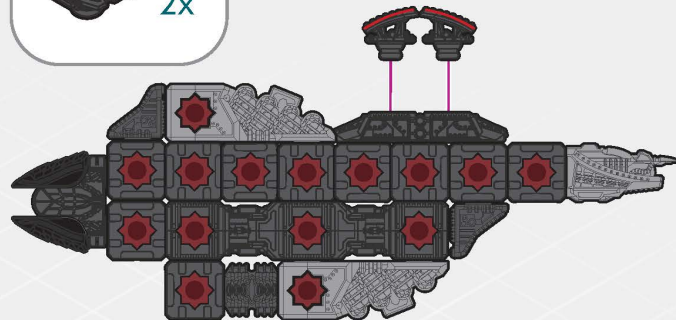

15

-  2x
-  2x
-  2x
-  2x

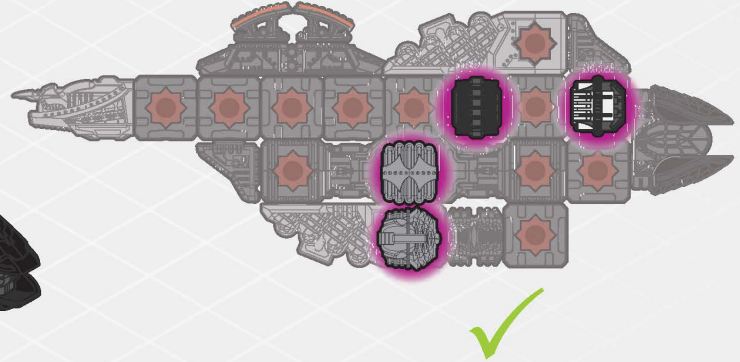
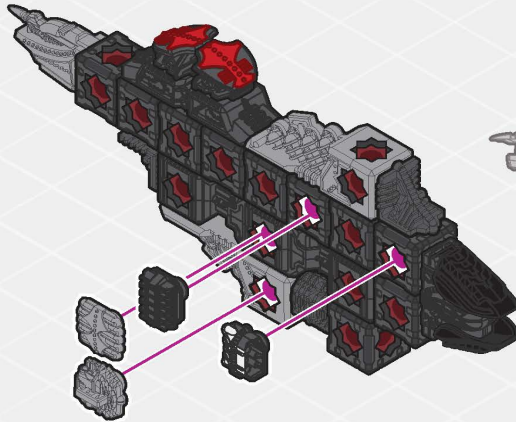
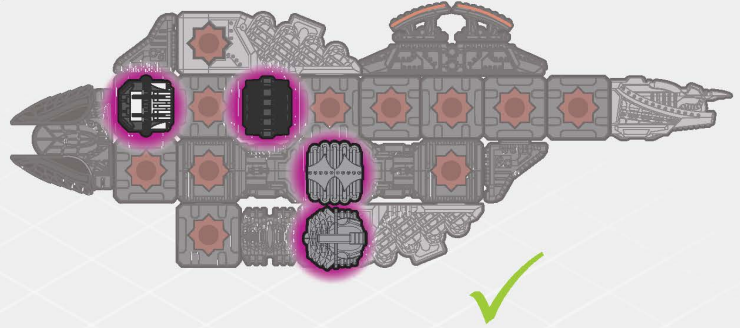
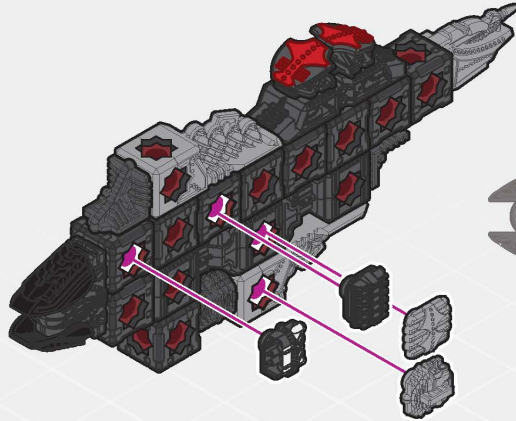

16

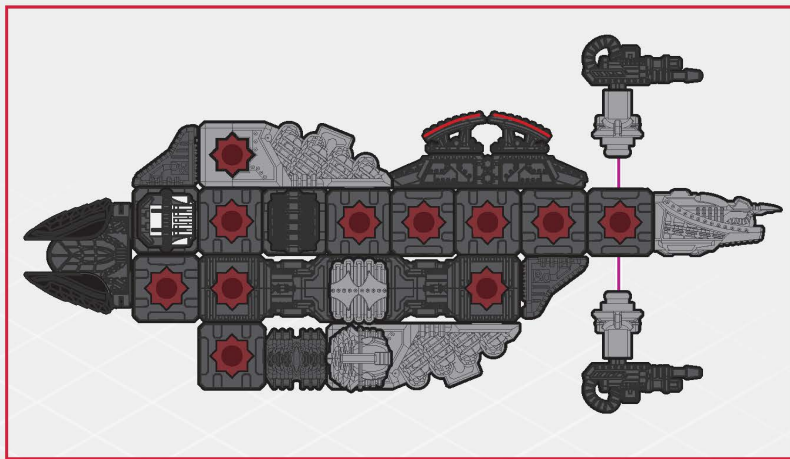
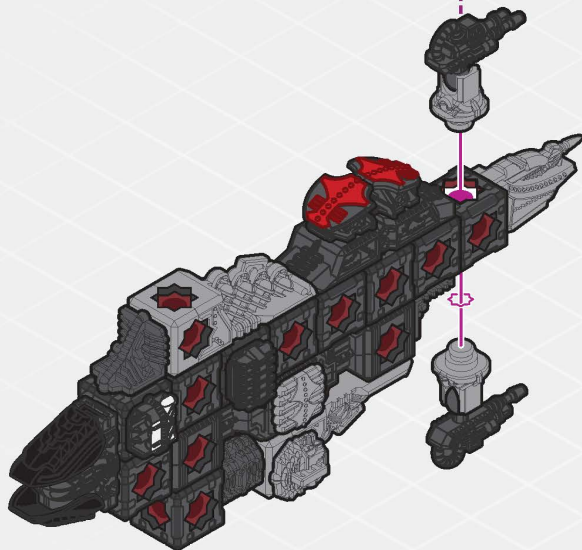
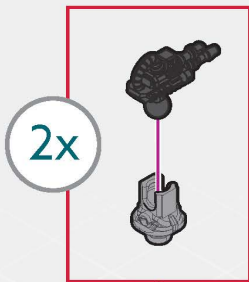
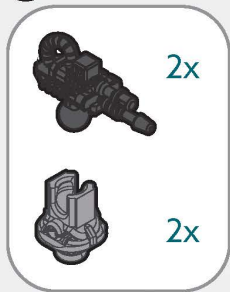

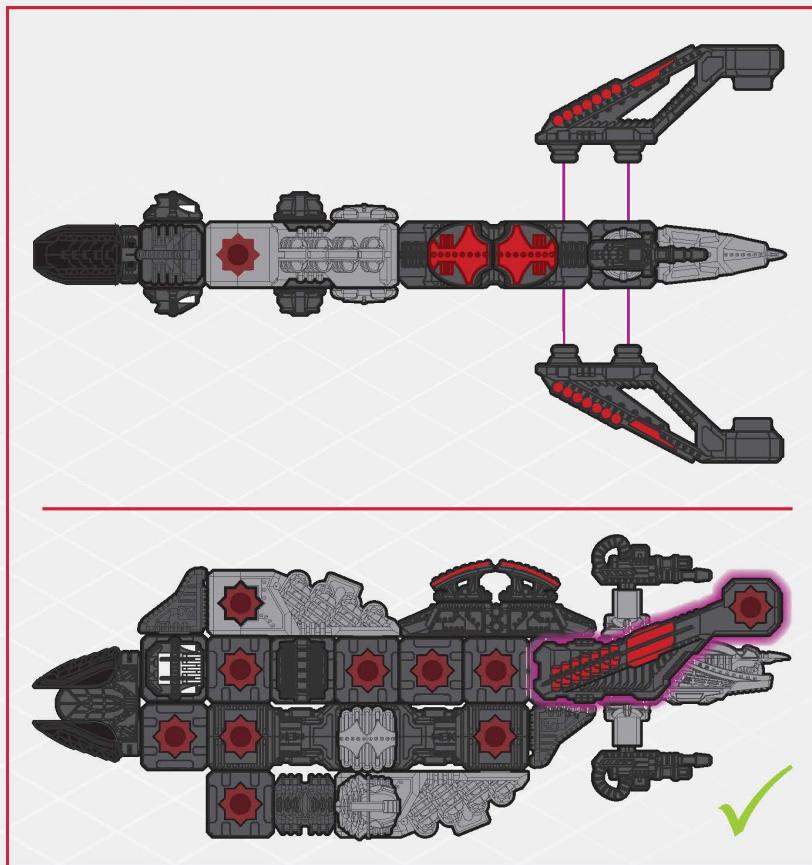
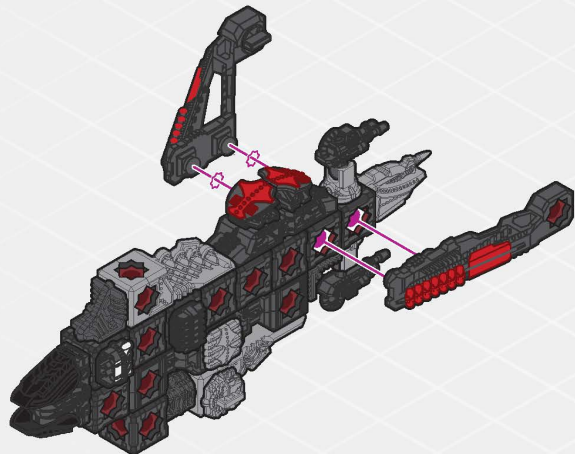
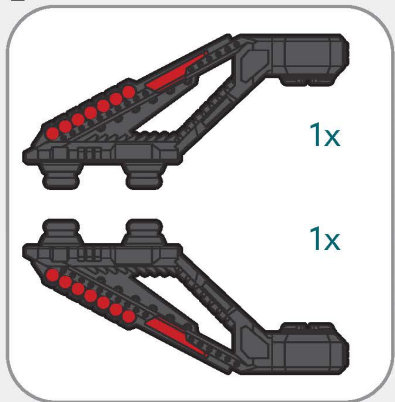

18

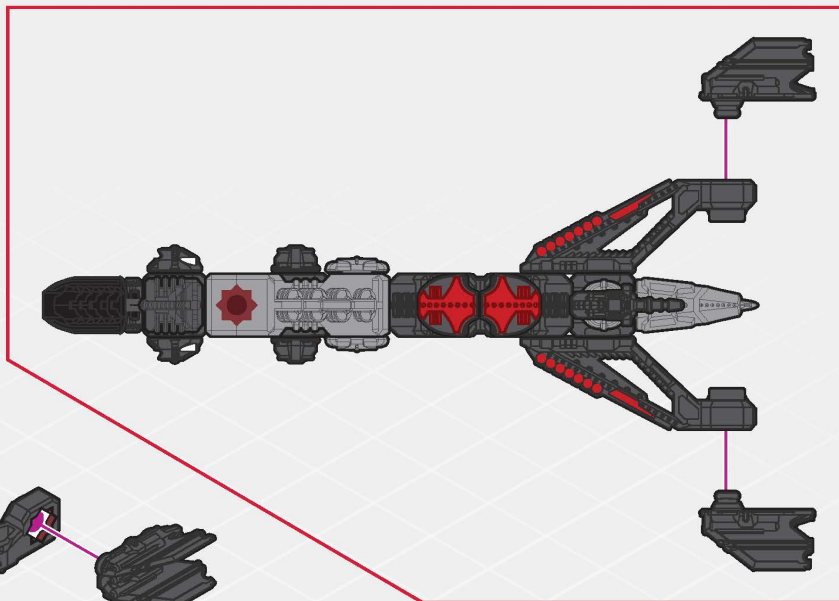
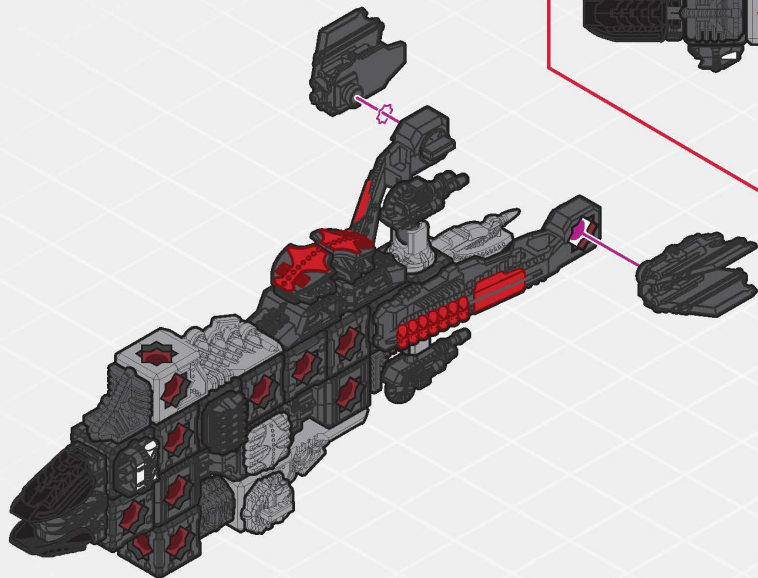

19

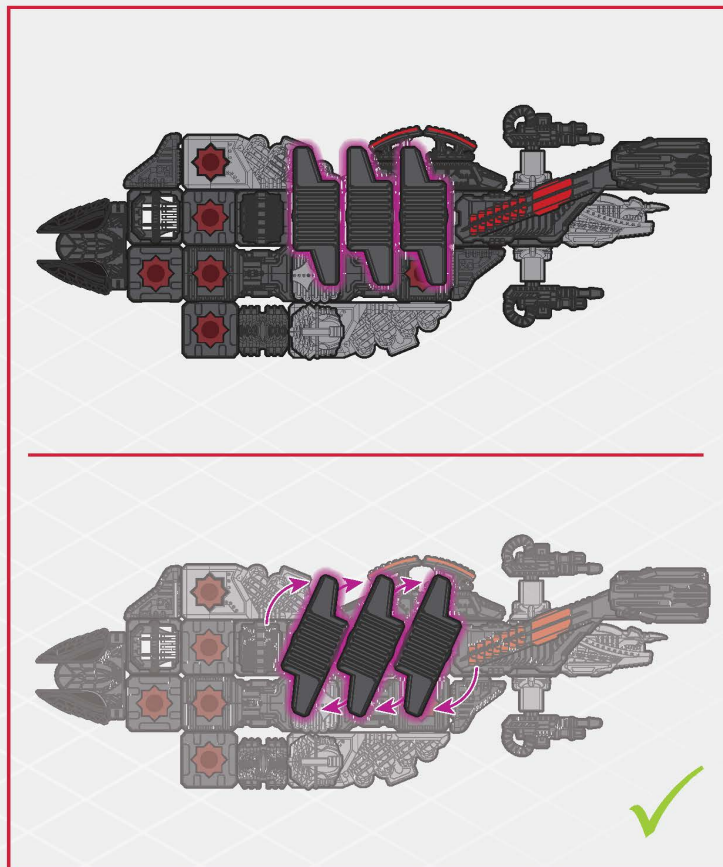
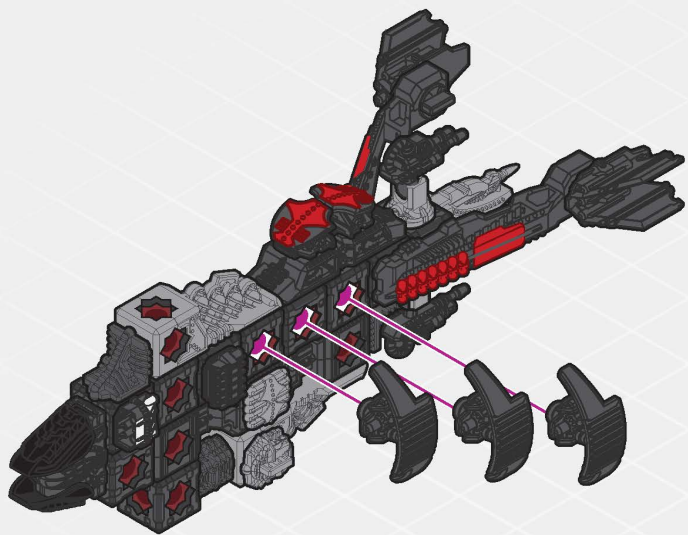

HAMMERJAW BUILD #2

20

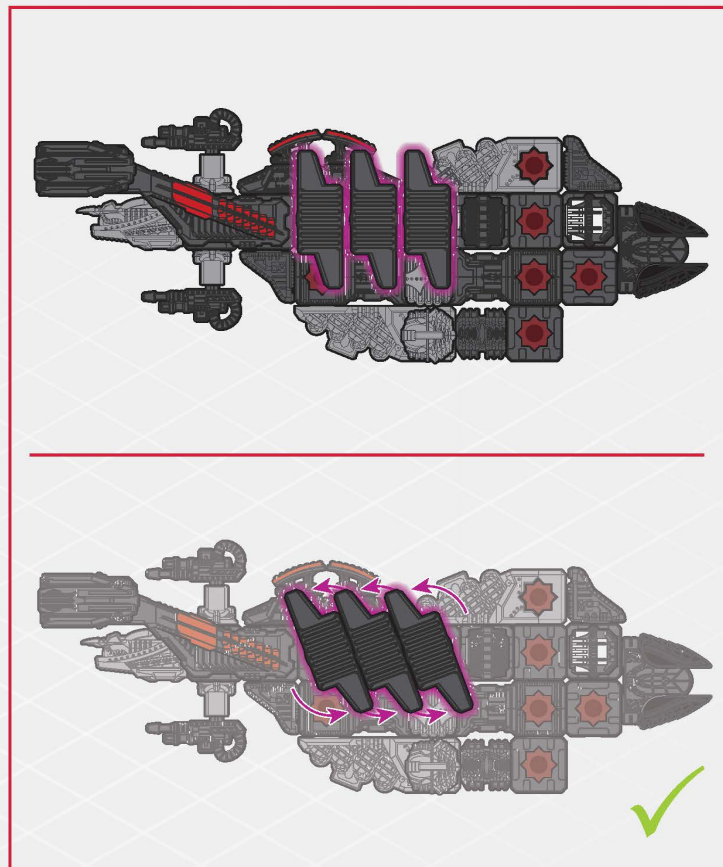
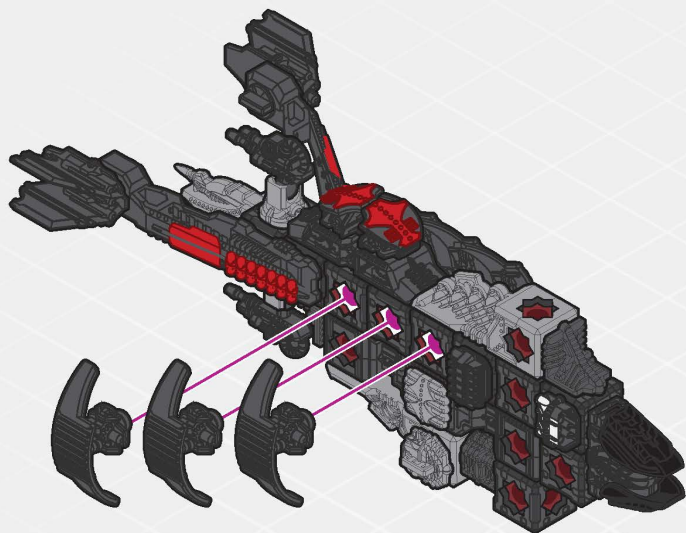

21

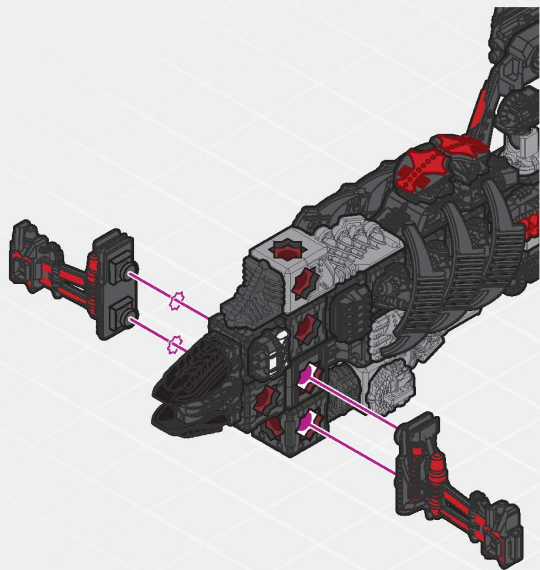

22

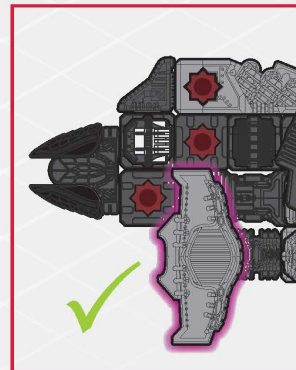
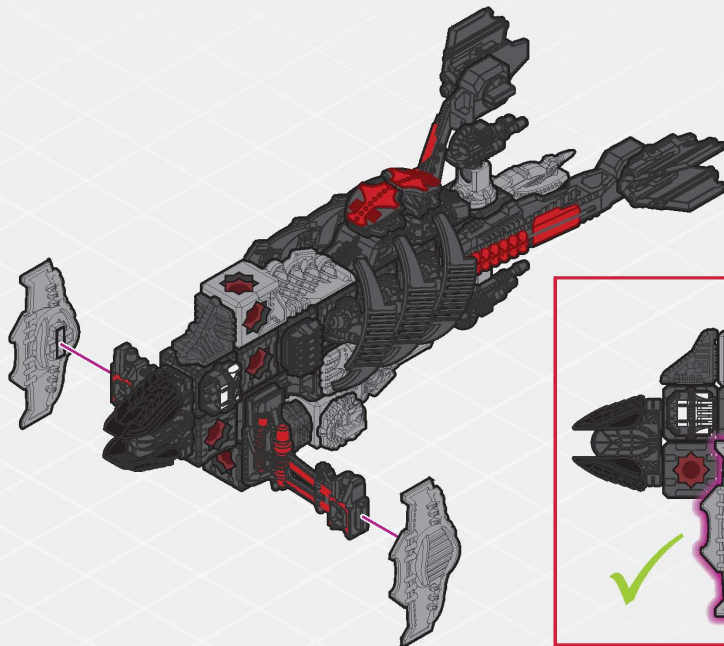
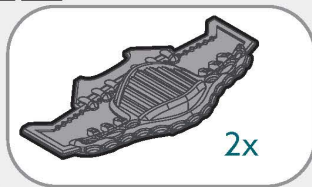

HAMMERJAW BUILD #2

23

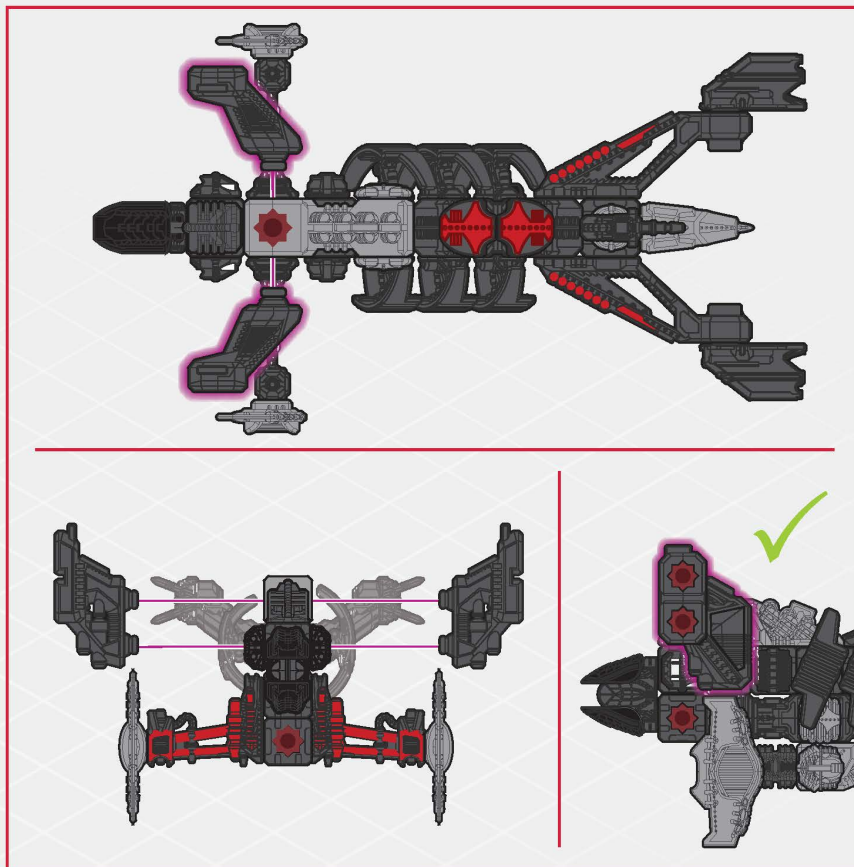
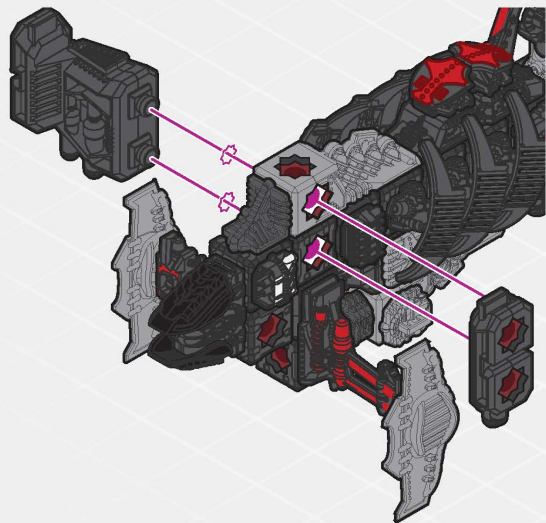
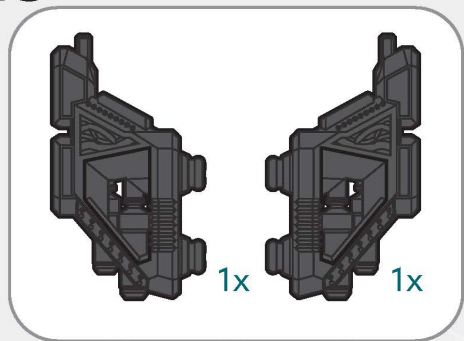

24

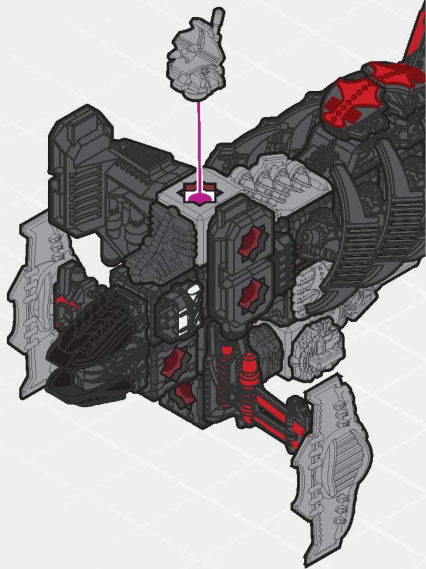

25

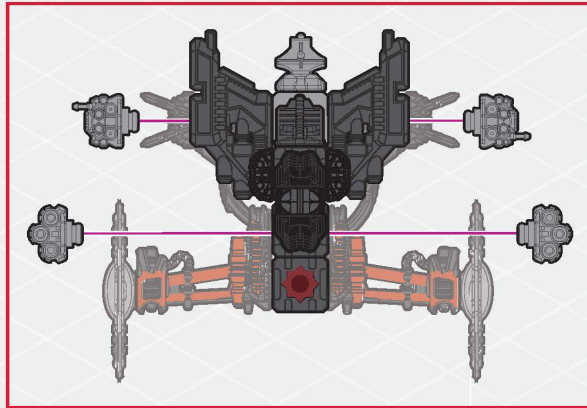
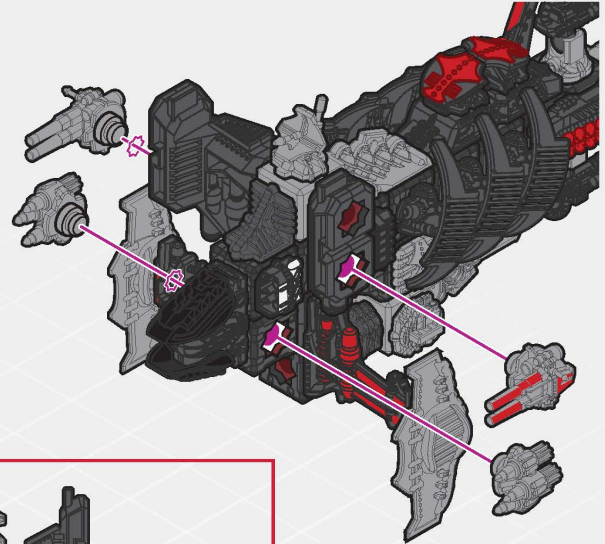
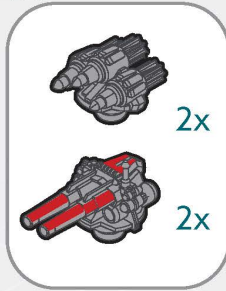

26

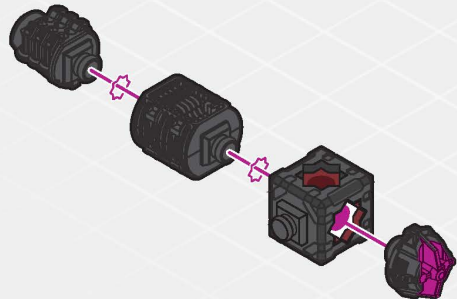
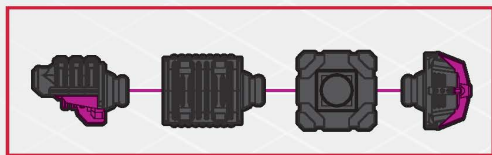

27

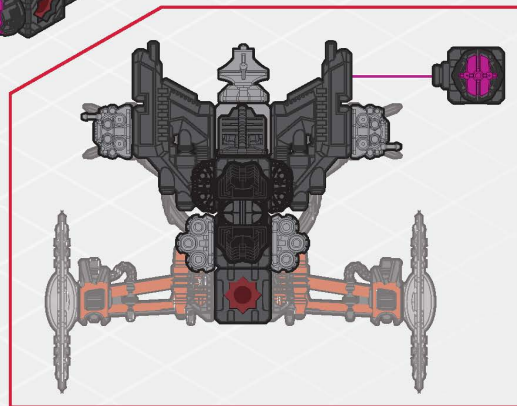
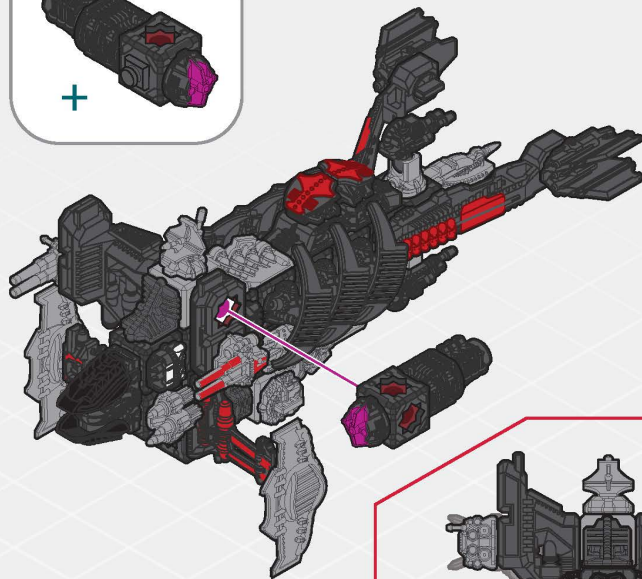

28

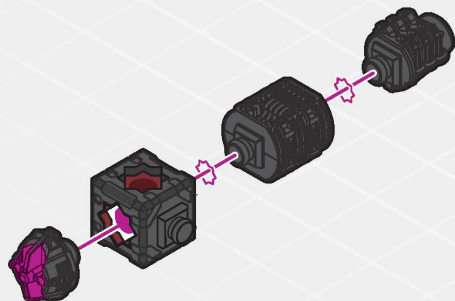
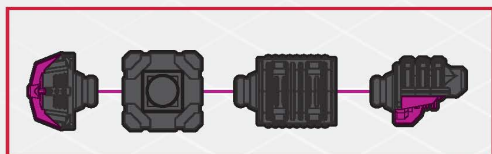

29

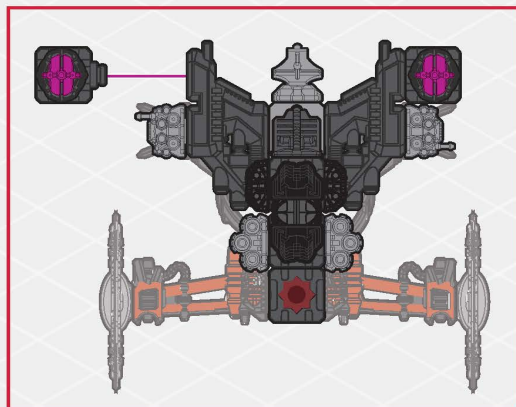
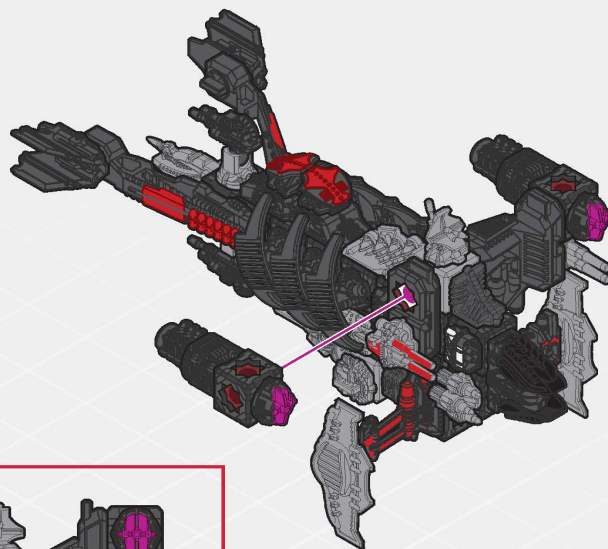

30

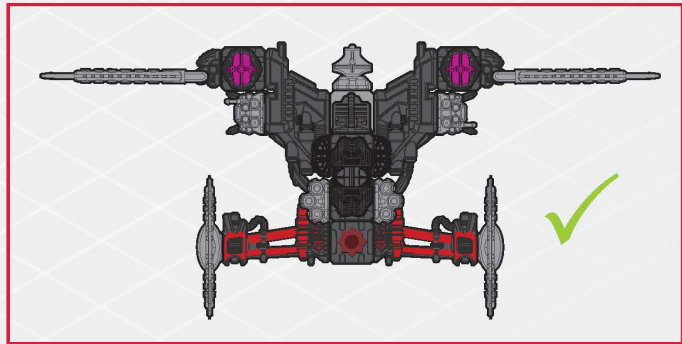
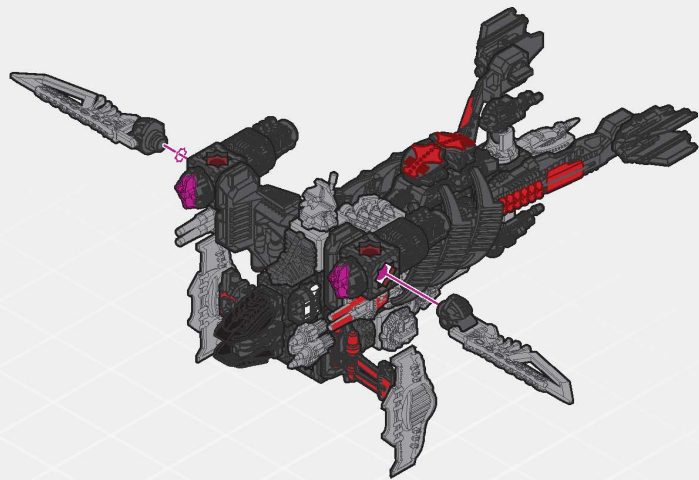
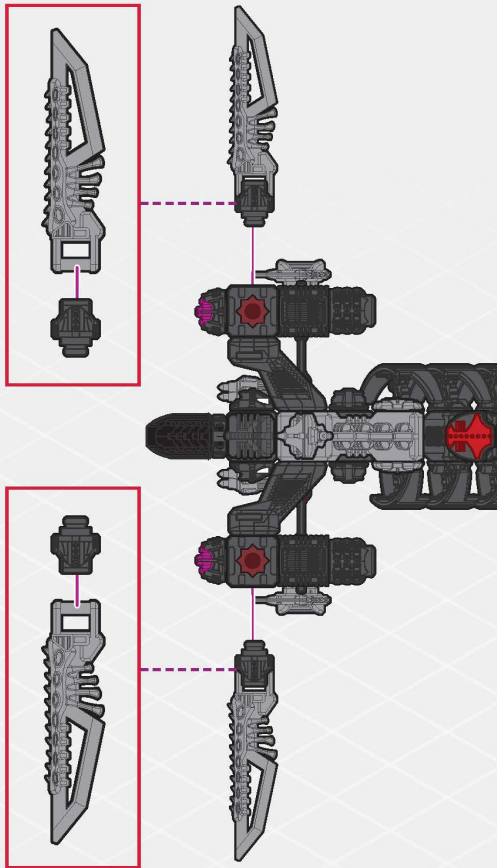
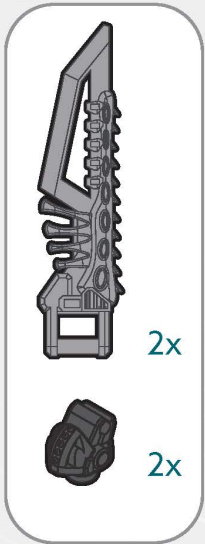

31

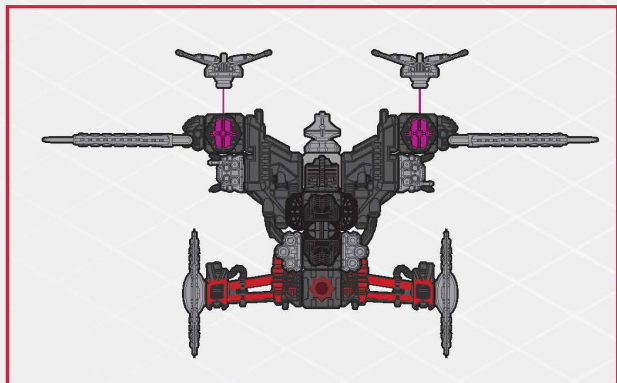
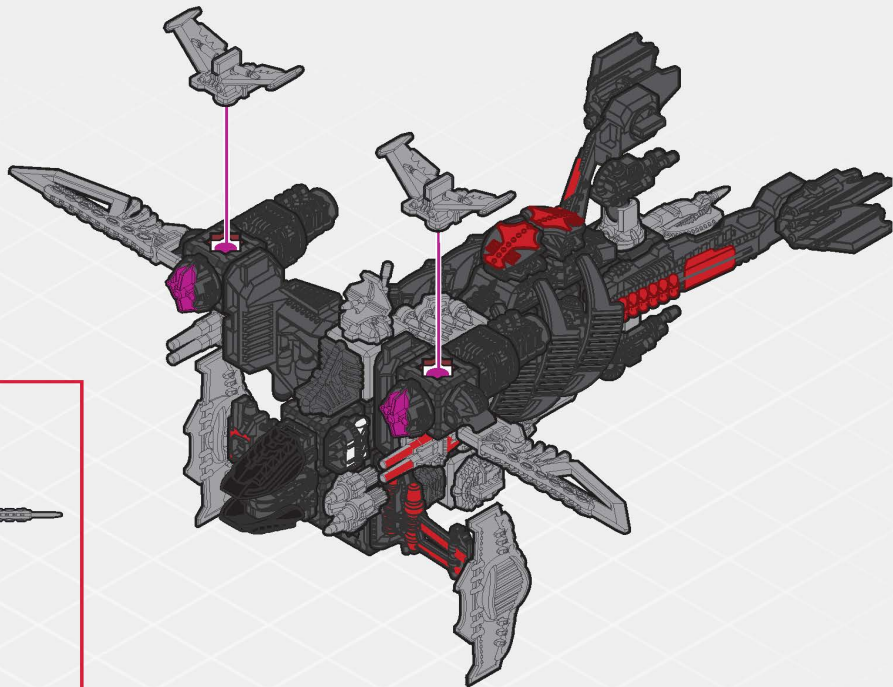
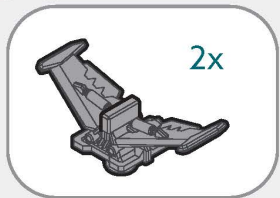

HAMMERJAW BUILD #2

32

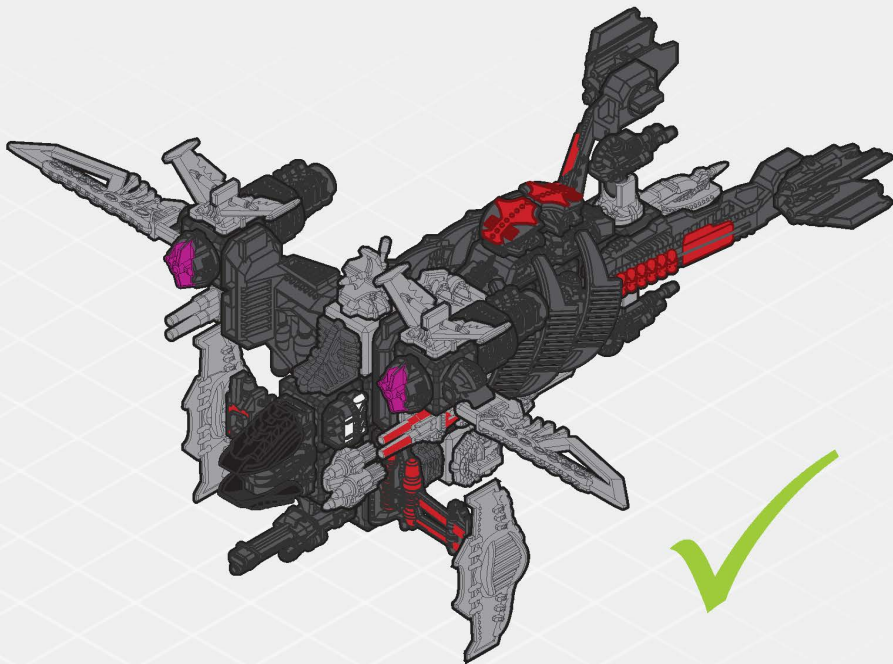
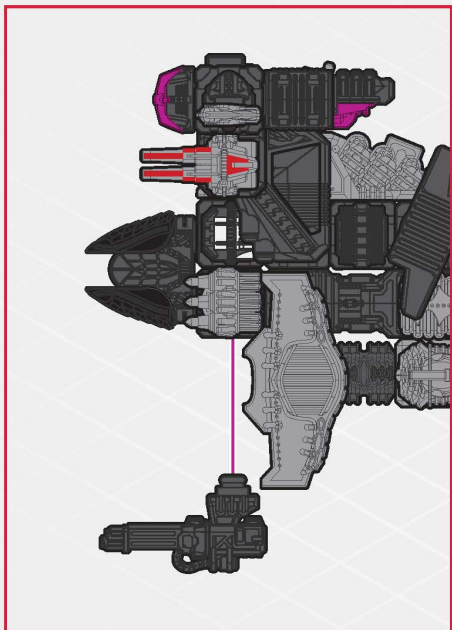



HAMMERJAW

K.L.A.W. AWACS
ORNITHOPTER

BUILD #3

1

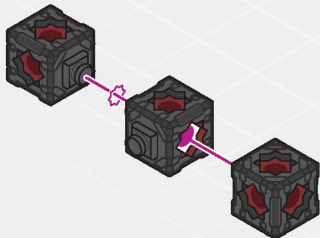
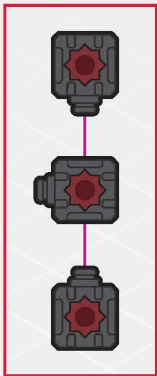

2

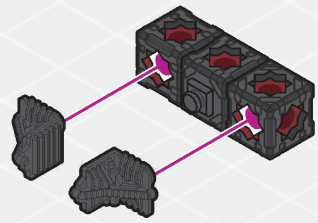
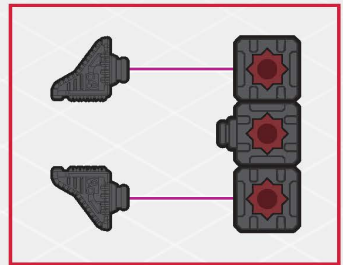

3

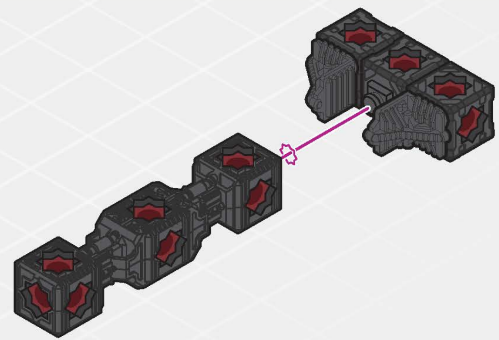
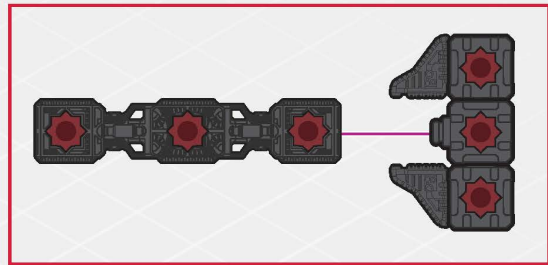
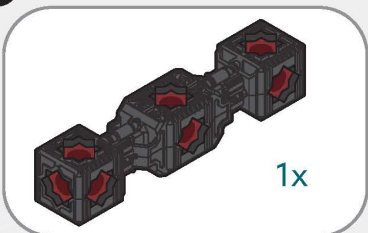

4

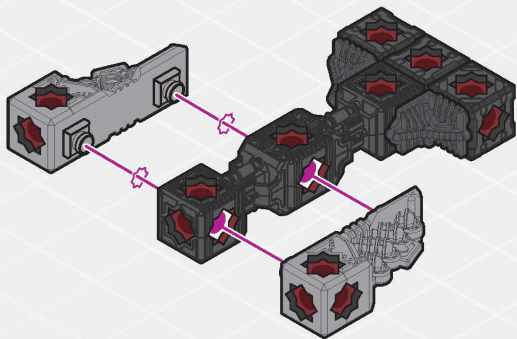
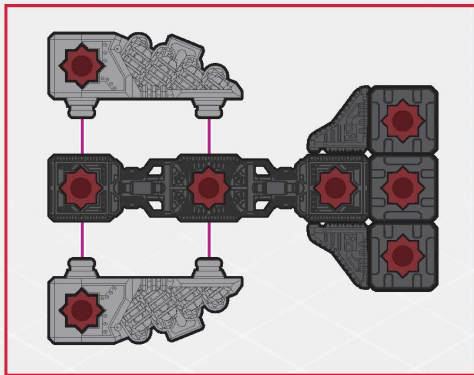
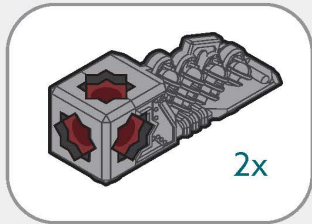

5

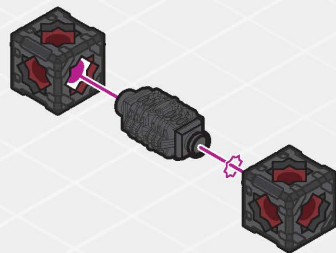
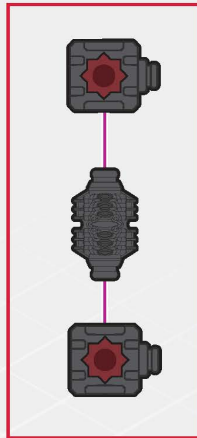

6

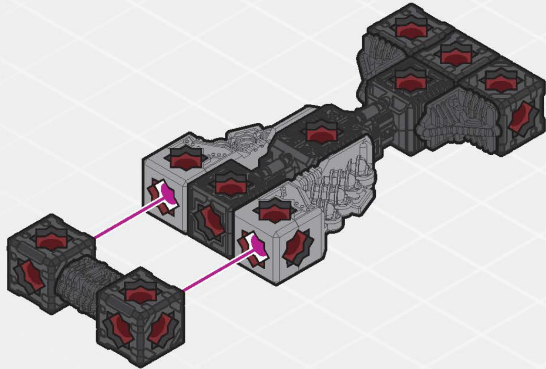
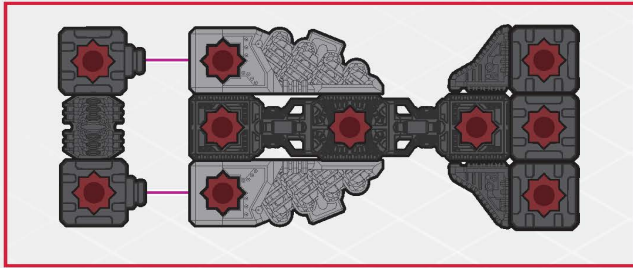

7

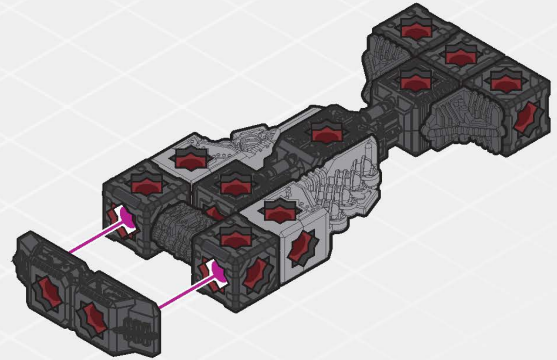
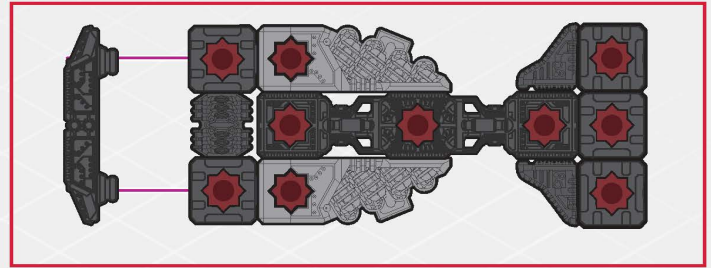
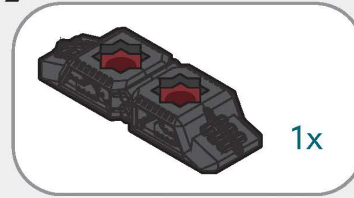

8

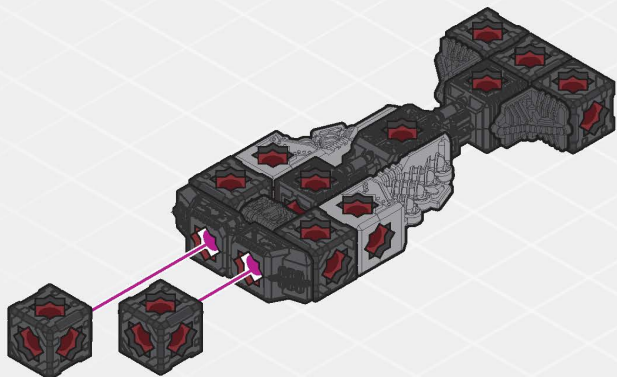
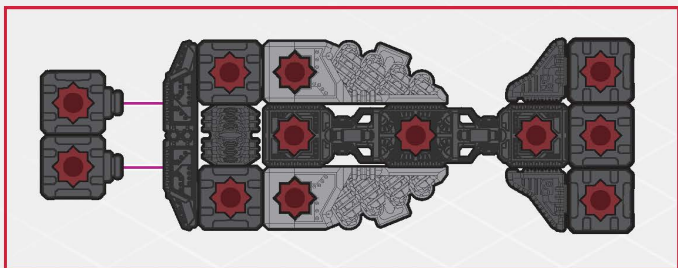

9

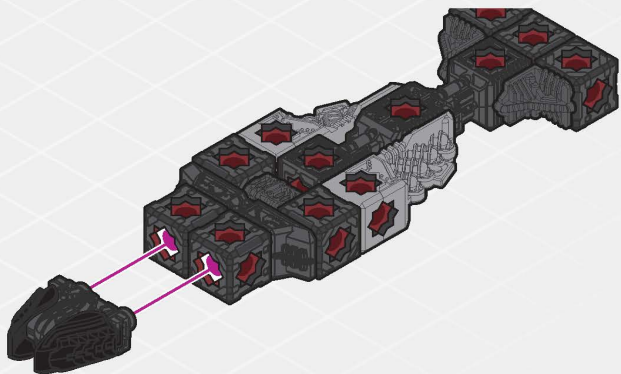
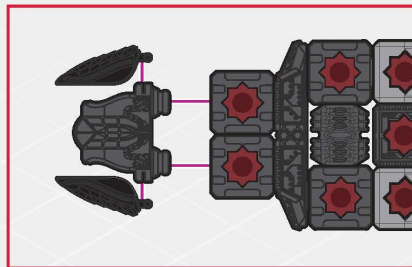

10

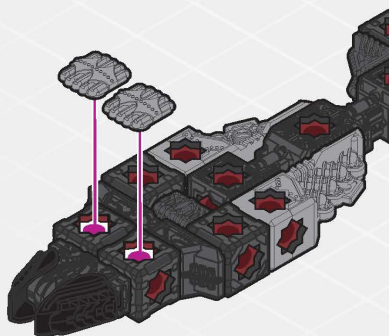
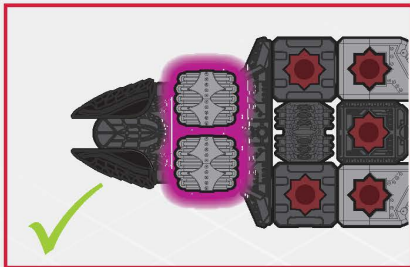

11

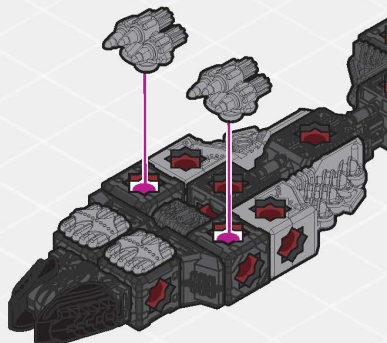

12

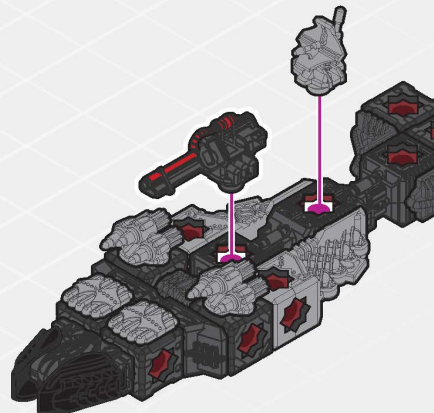
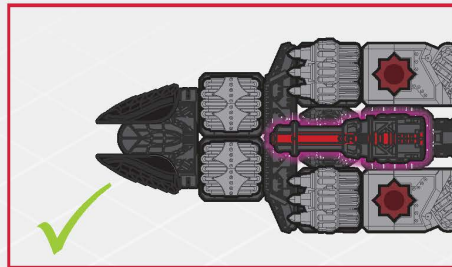
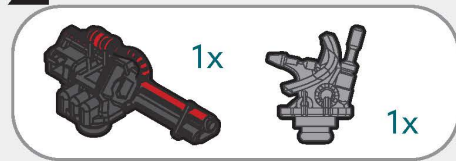

13

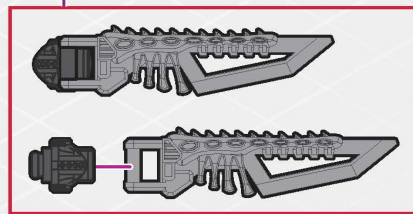
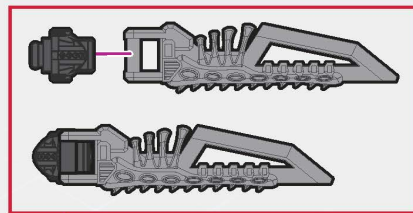
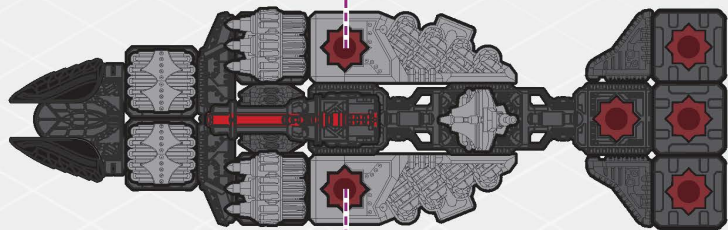
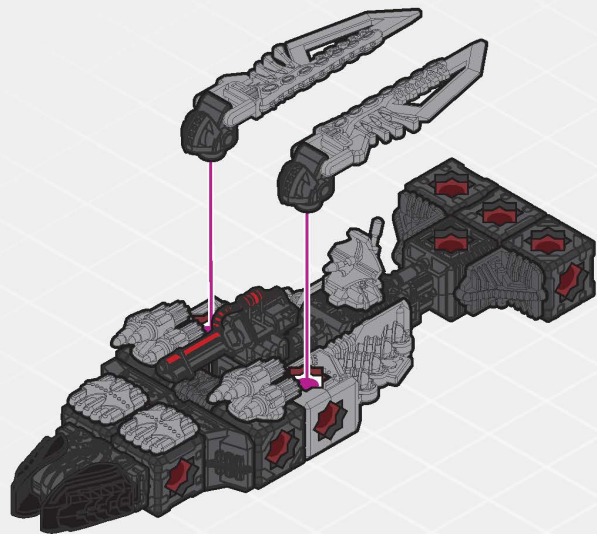

14

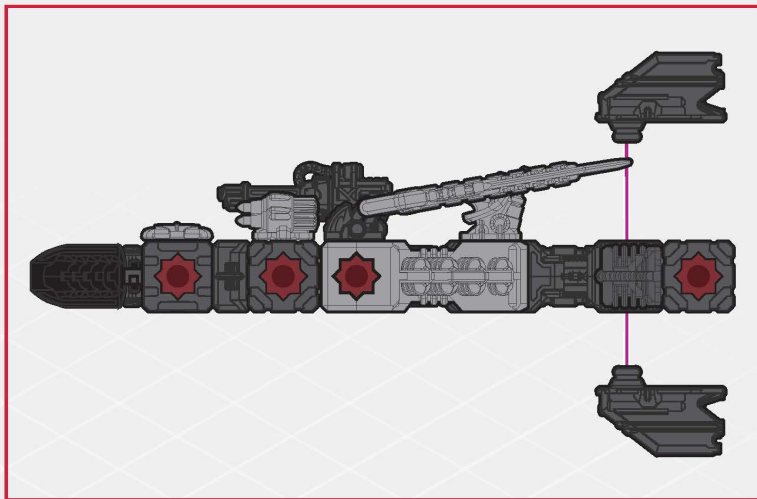
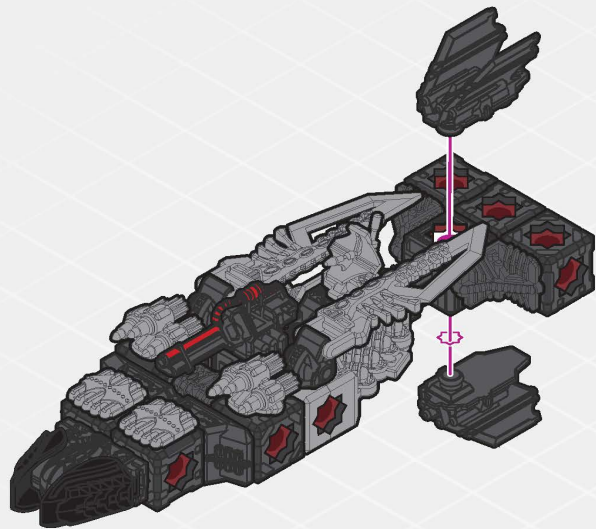

15

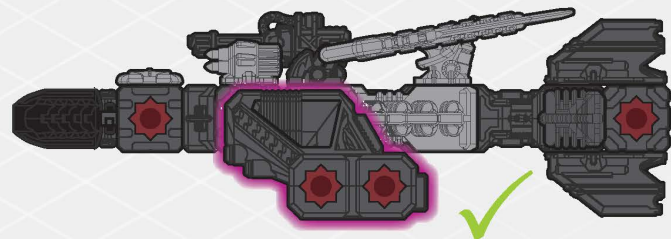
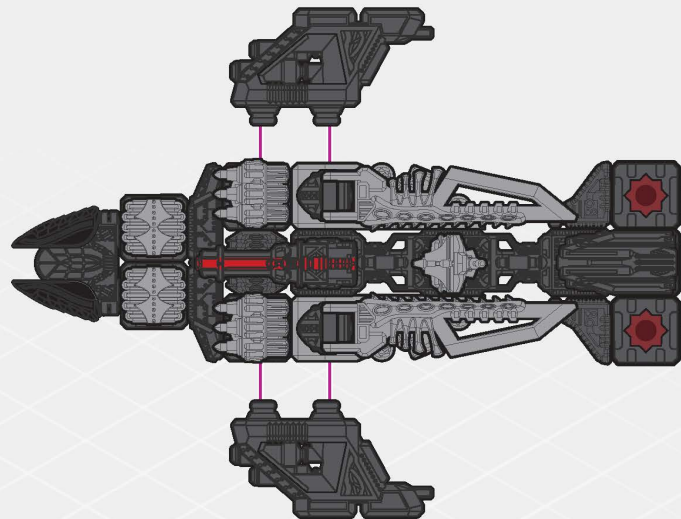
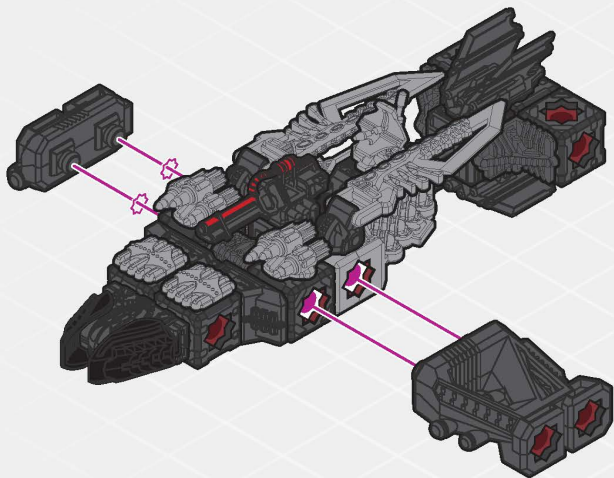
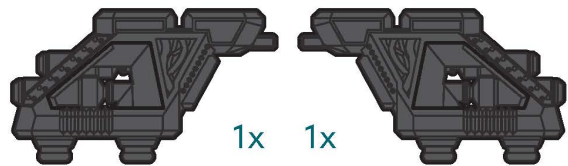

16

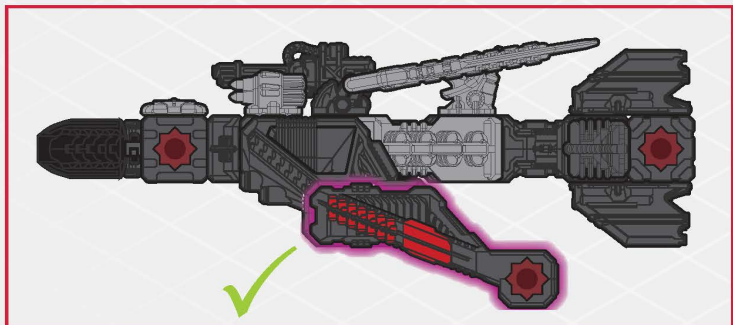
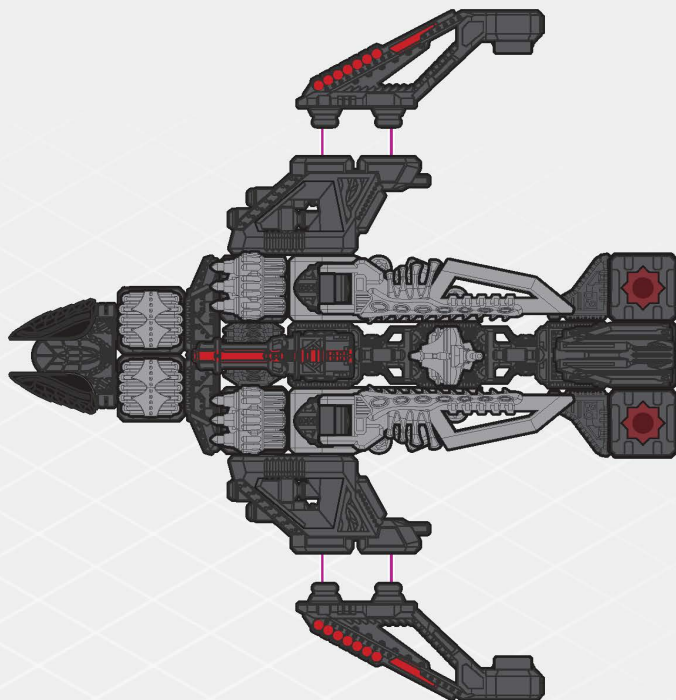
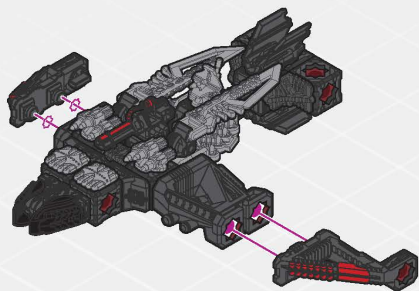
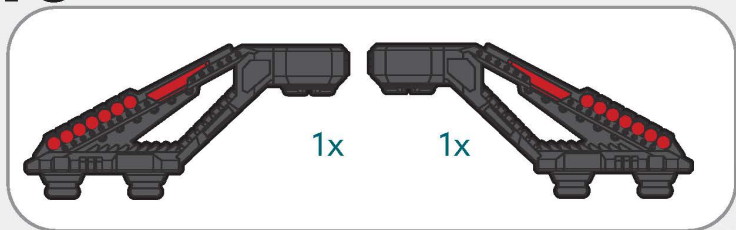

17

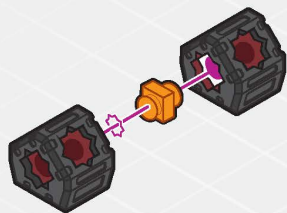

18

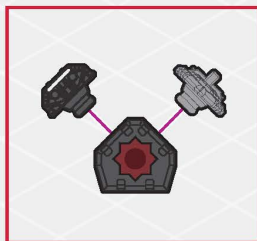
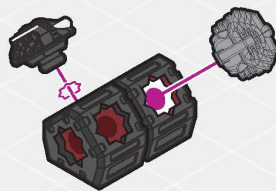

19



20

+



1x

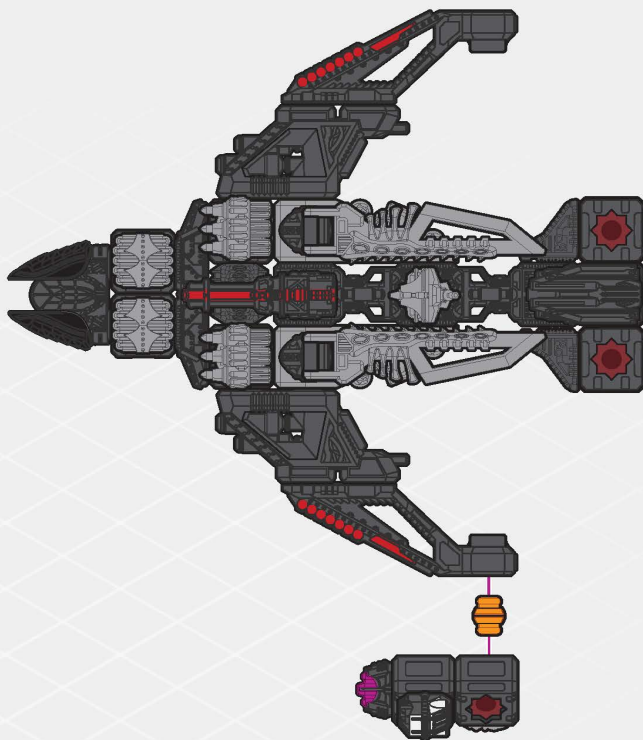
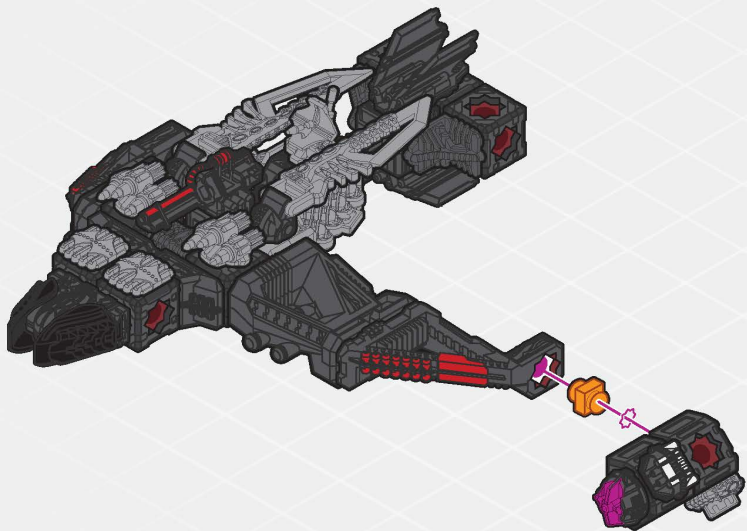

21

HAMMERJAW BUILD #3

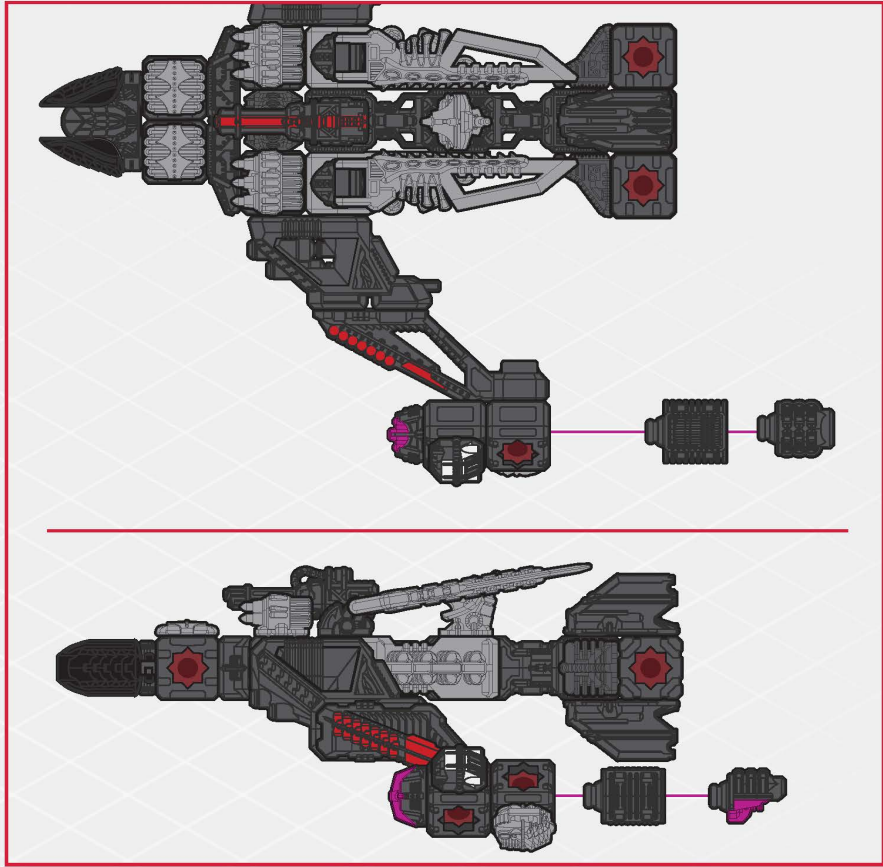
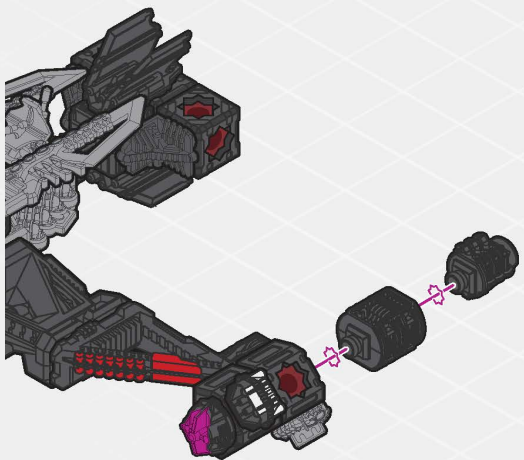
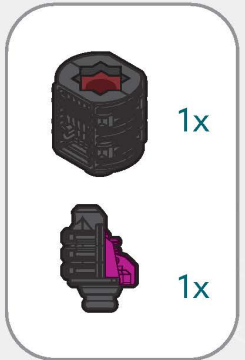

22

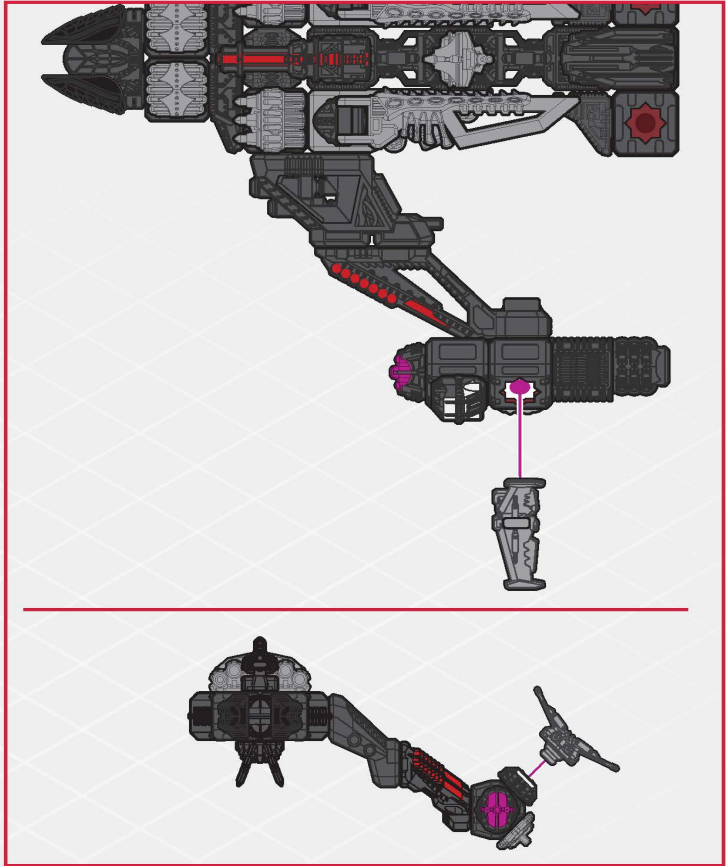
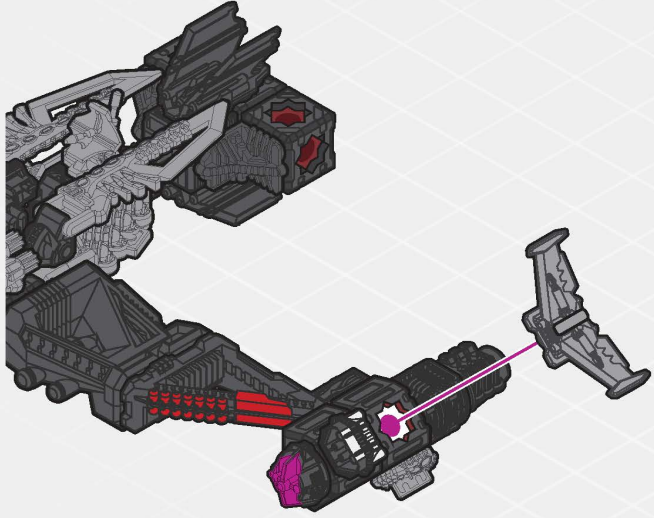

23

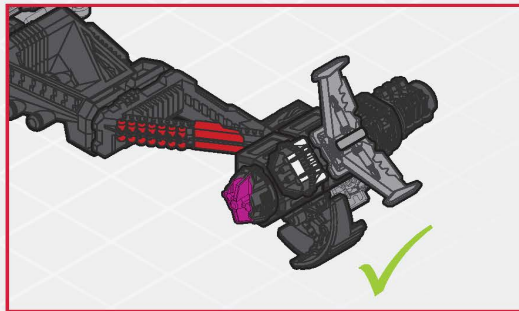
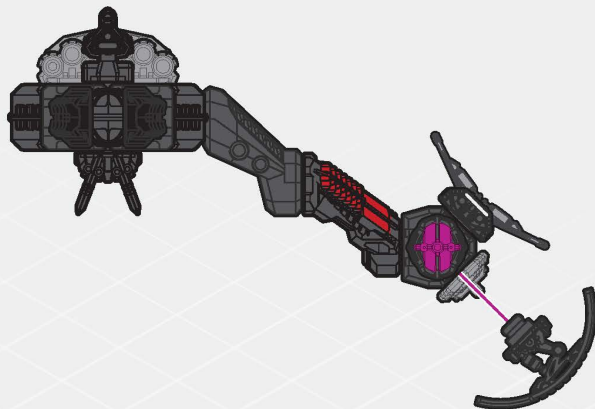
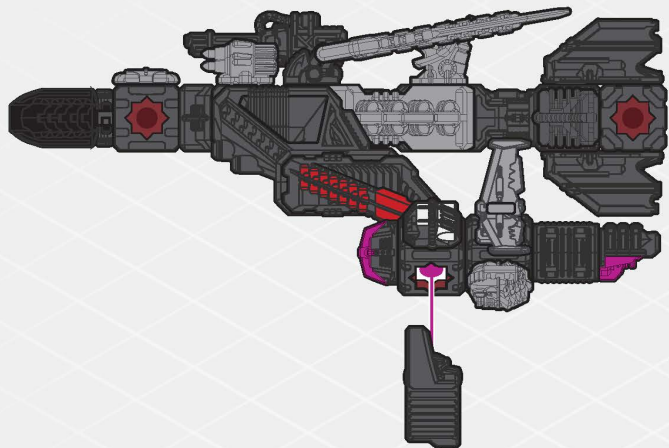

24

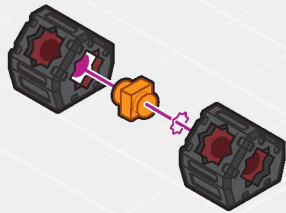

25

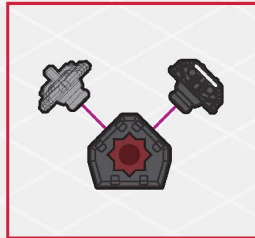
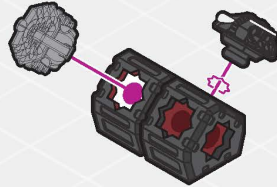

26

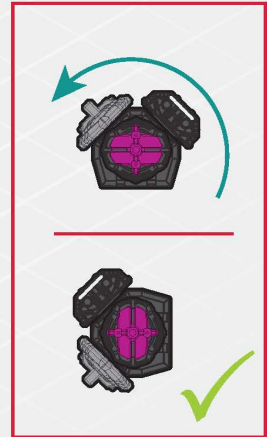

27

+



1x

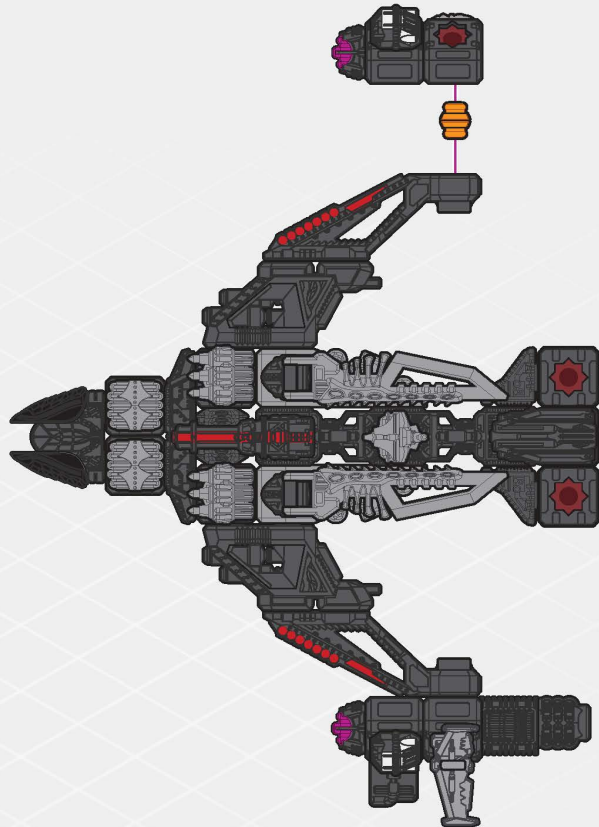
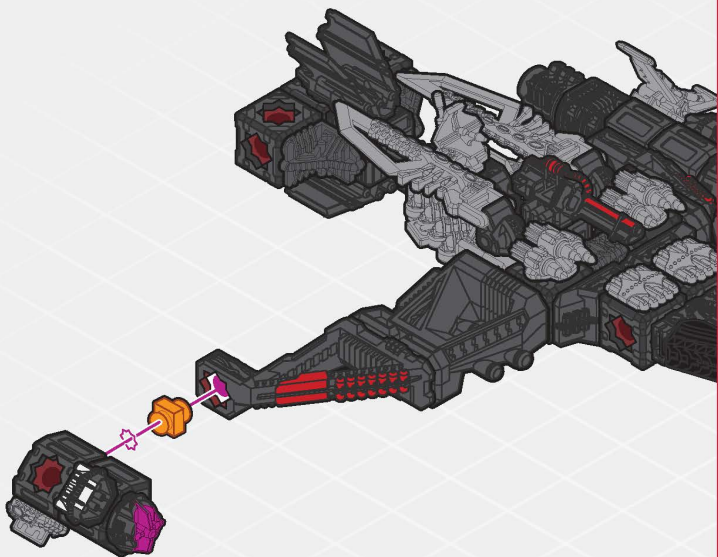

28

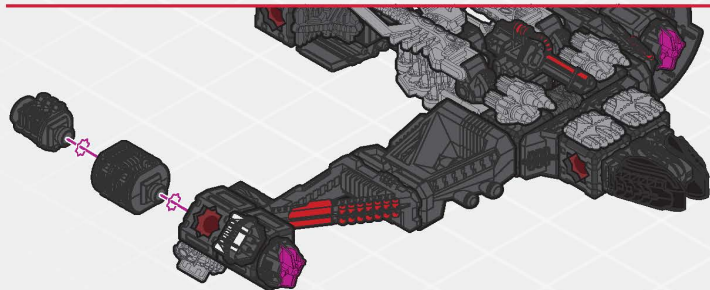
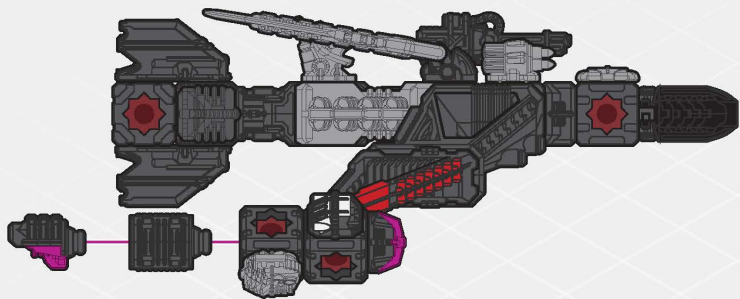
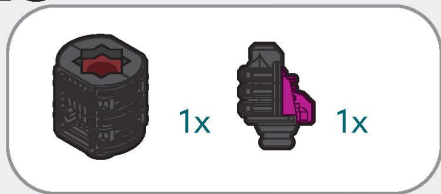

29

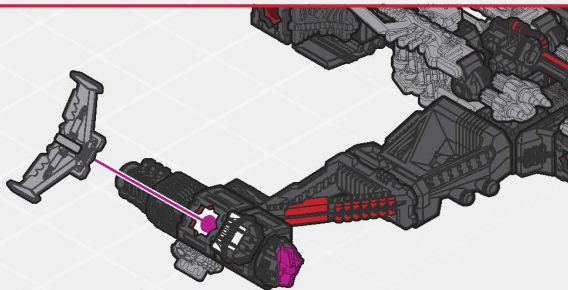
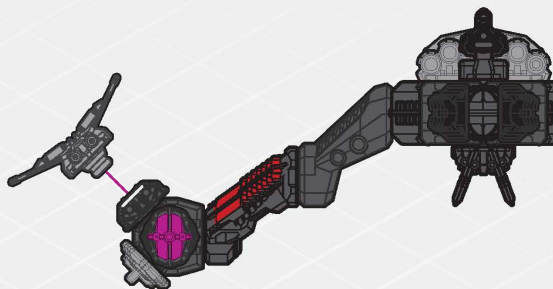

30

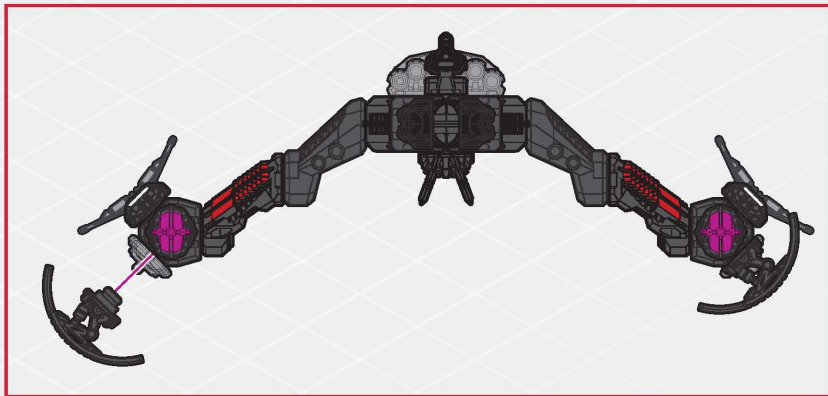
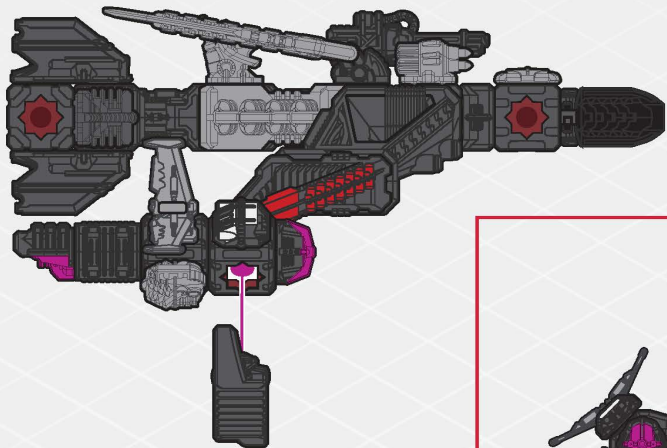

31

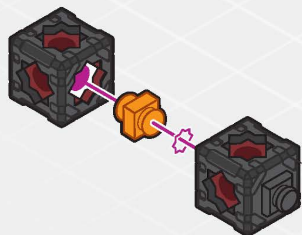
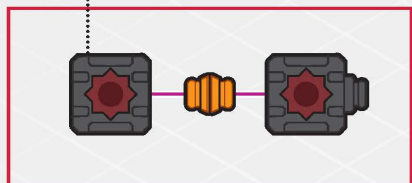

32

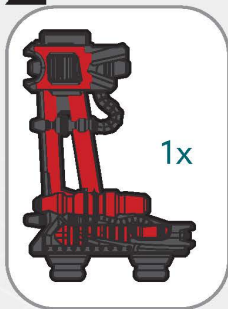

33

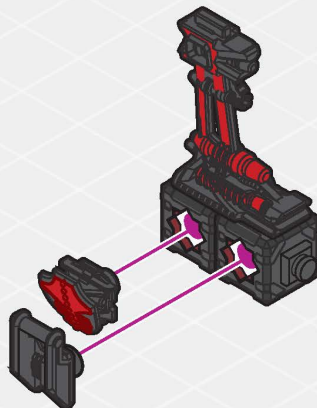

34

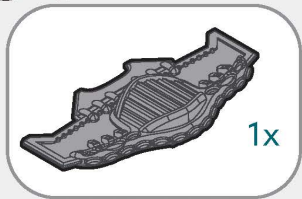

35

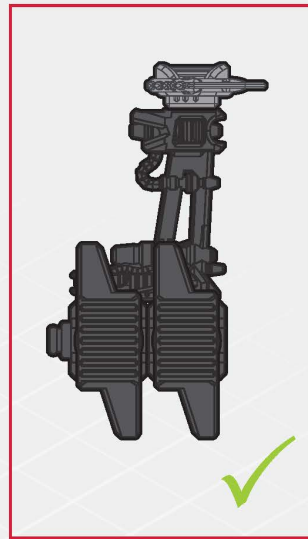
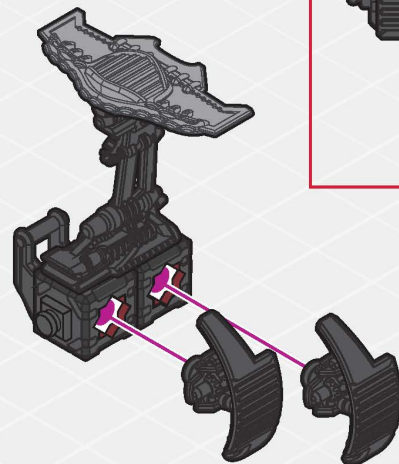
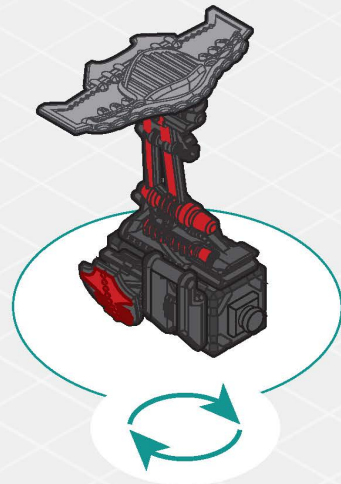

36

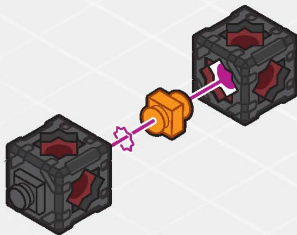
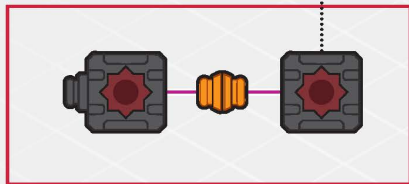

37

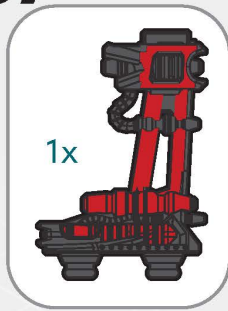

38

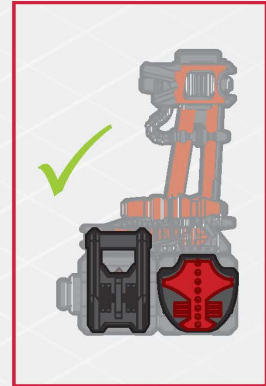
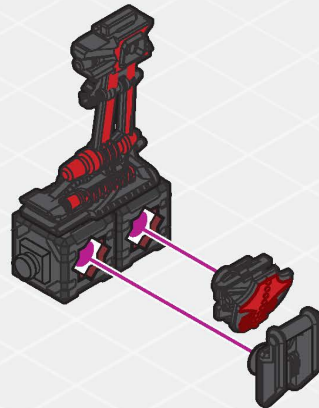

39

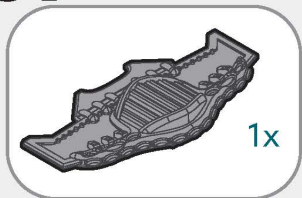

40

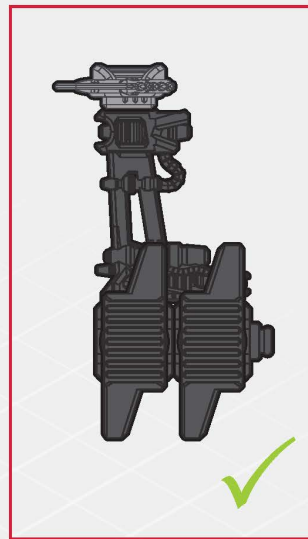
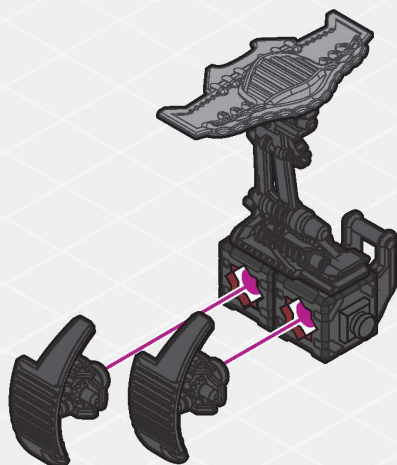

41

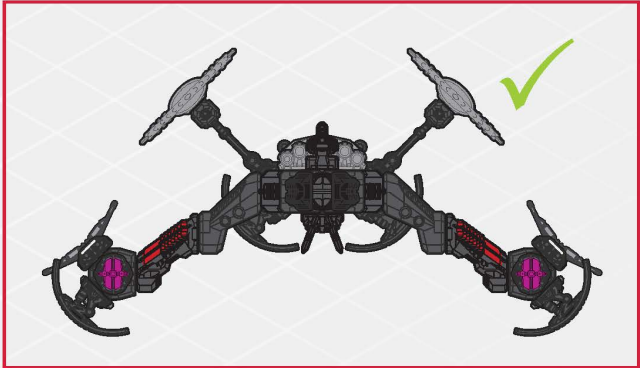
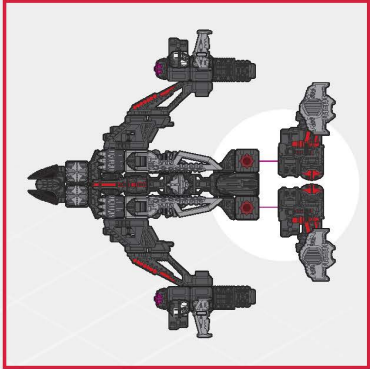
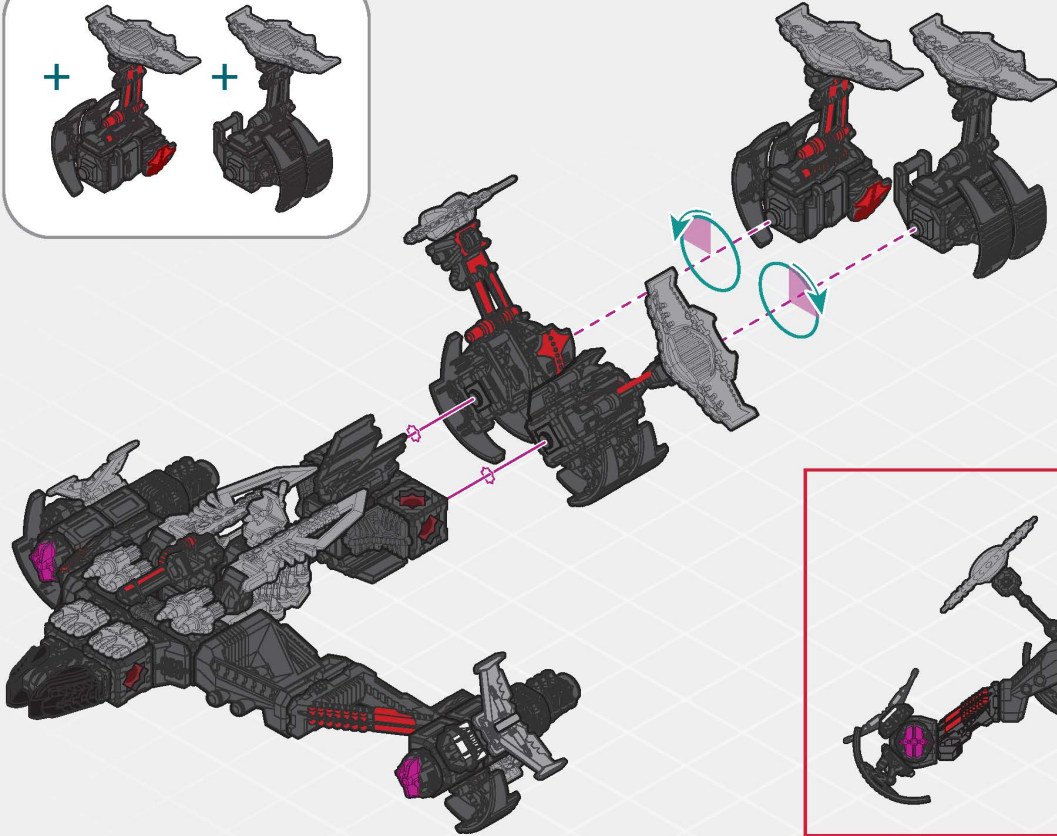
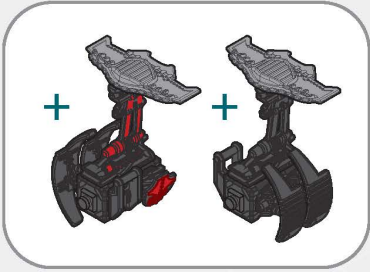

42

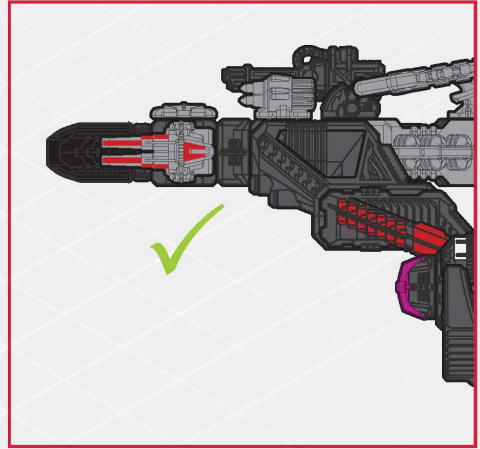
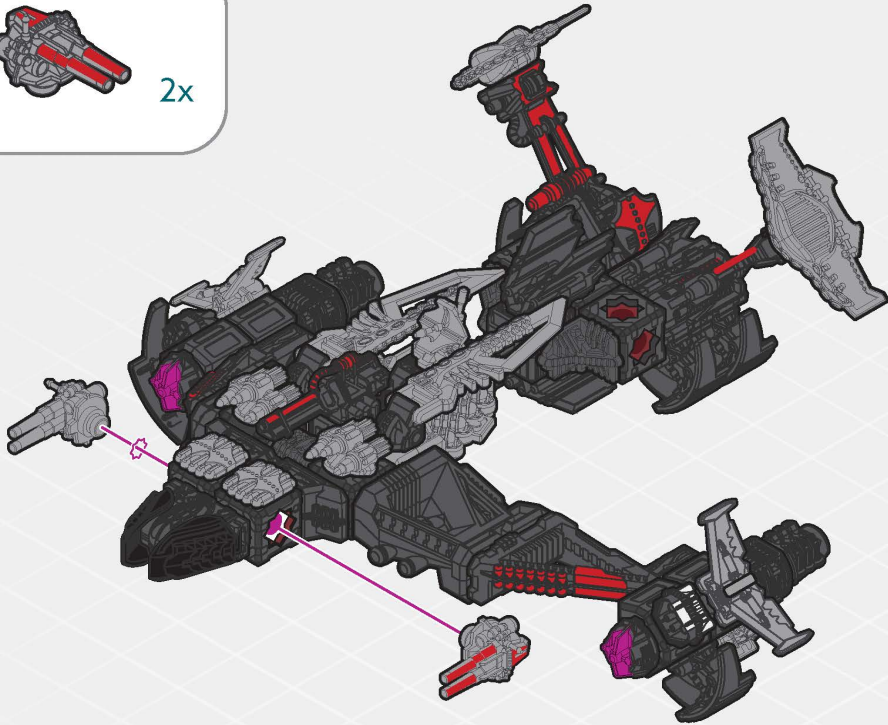
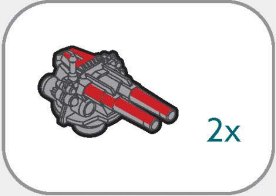

43

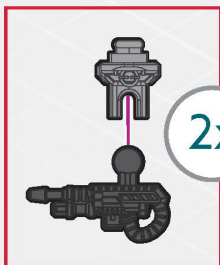
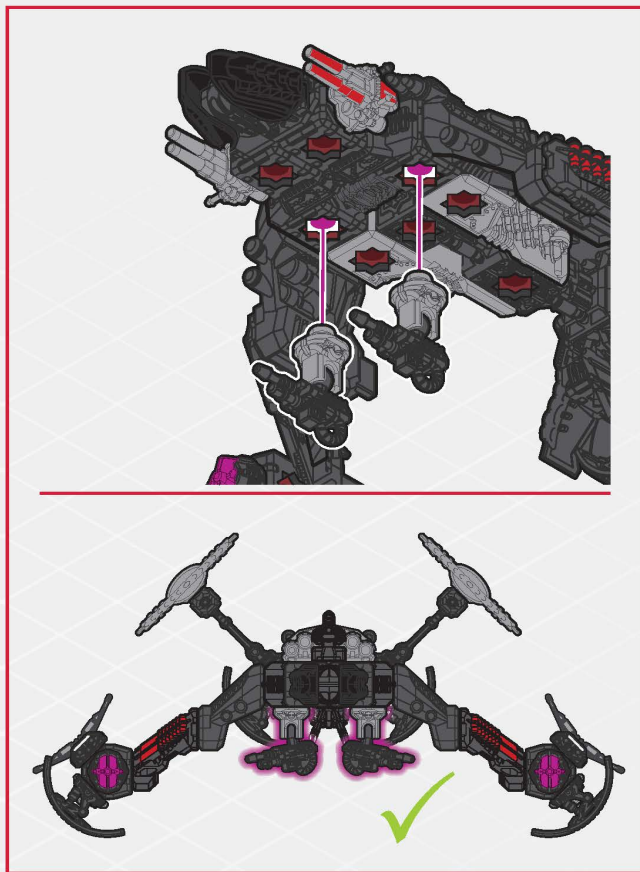
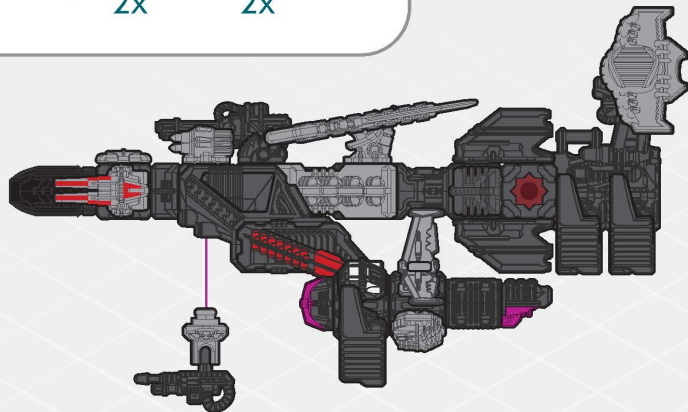

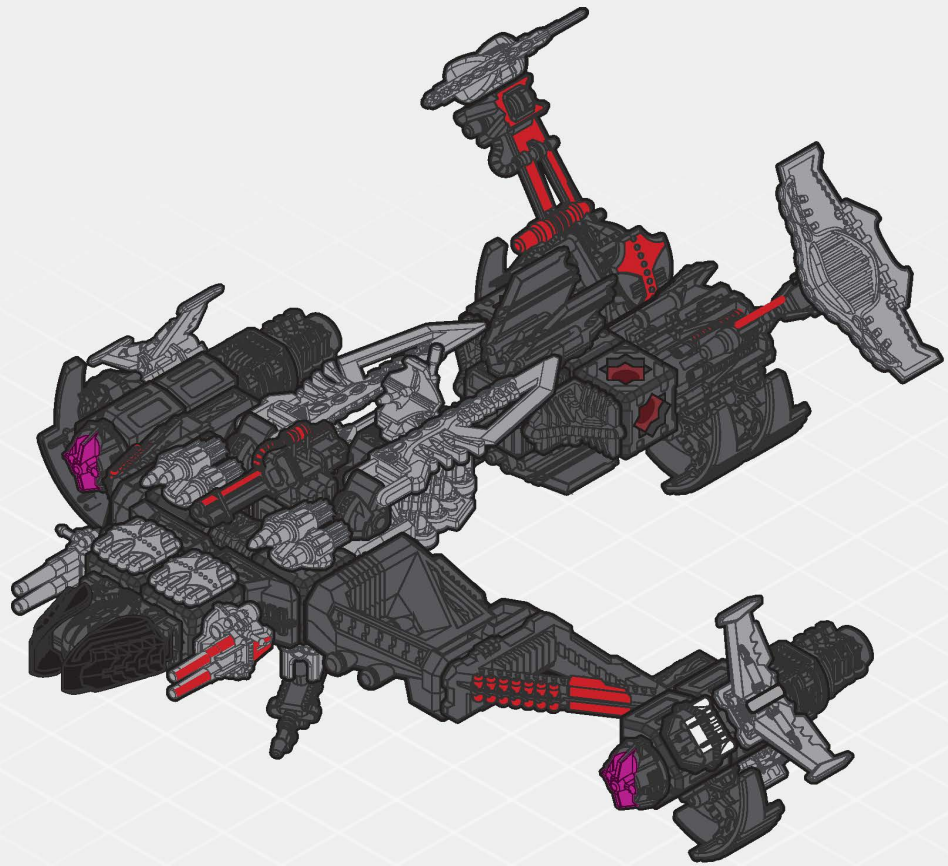

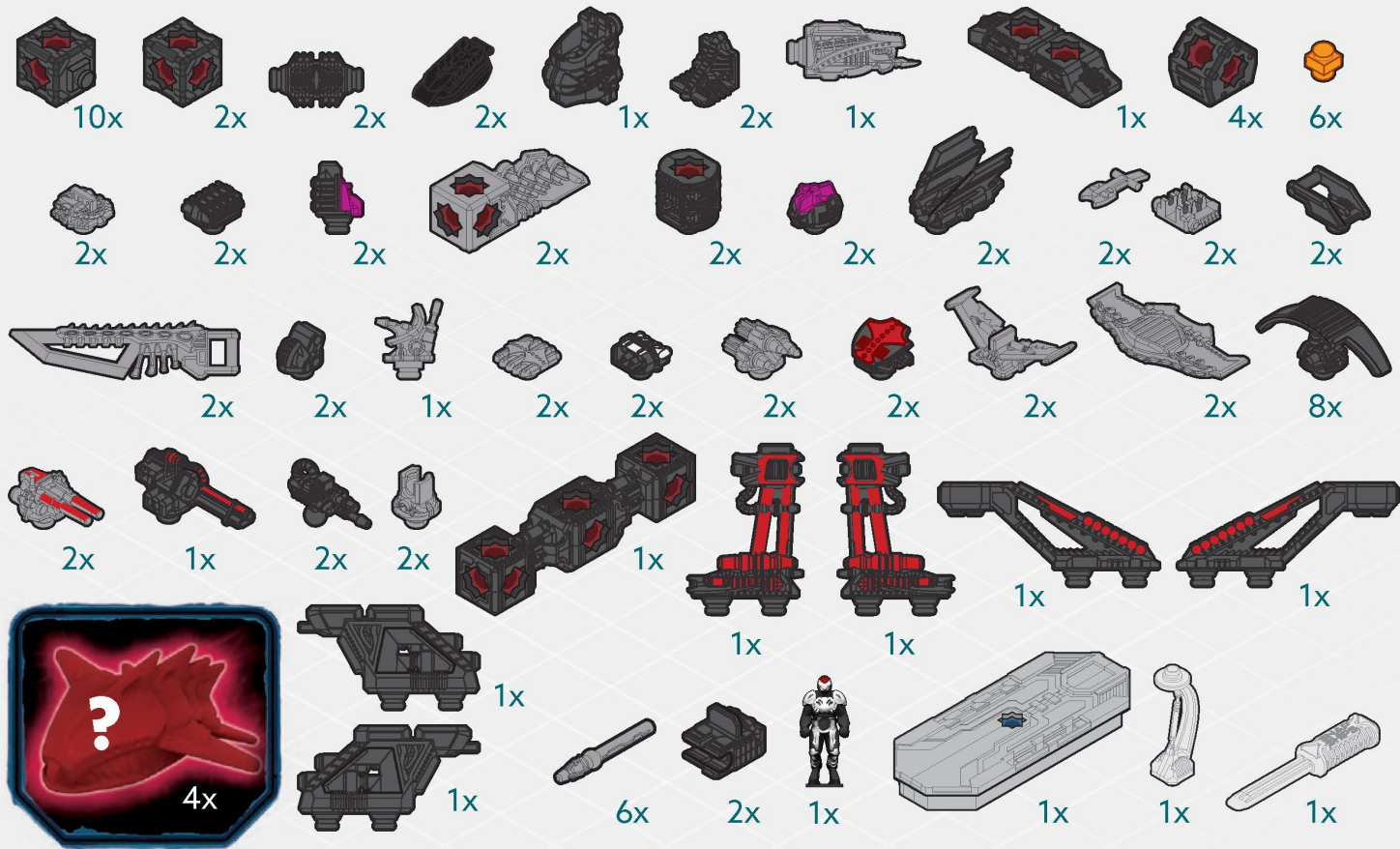

COMPONENTS



APP
Ask a Parent First

Download
the Snap Ships
app for
interactive
builds
and play

COLLECT THEM ALL!



www.snapships.com

Watch Action-Packed Videos!

9526

Instructions can be downloaded at:
snapships.com

If you have questions, please contact us.
800-524-4263 * Weekdays 8am to 5pm CST
playmonster.com/contact-us

PlayMonster.



Copyright © 2021 PlayMonster LLC, 1400 E. Inman Pkwy., Beloit, WI 53511 USA.
Made in China. All rights reserved. **Snap Ships** and **Build to Battle** are trademarks of
Snap Ships, LLC. **Snap Ships** used under license. Copyright © 2021 Snap Ships, LLC.
Parts and colors may vary from those shown. Invented by Scott Pease and Jeff Swenty.