

# SNAP SHIPS®

BUILD TO BATTLE®

## CLAYMORE

CR-76  
COMBAT  
TRANSPORT  
- P. 4



STV-TERRIER BIPEDAL  
ASSAULT DRONE  
- P. 44



AP-64 BIPED MECH  
DRONE  
- P. 54





Download  
the Snap Ships  
app for  
interactive  
builds  
and play

## THE THREAT TO HUMANITY CONTINUES...

The brutal aliens of the Komplex are still spreading through the galaxy in an attempt to defeat and assimilate all other species. The elite team of the Forge is humanity's last line of defense against the enemy threat.

With the versatile, modular spacecrafts known as Snap Ships, both the Komplex and Forge have an armada of attack crafts, bombers, drones, mechs and more to configure and reconfigure to optimize their strengths in the fight to survive.

Now that you are part of the Snap Ships universe, how will you  
▶▶ **BUILD TO BATTLE?!** ◀◀

## THE MYSTERY OF UJU TECH

An ancient civilization, UJU KON, has left behind their advanced technology. The Forge and Komplex find and collect these tech pieces to add to their Snap Ships for more power and unheard-of abilities. Unlike the modular Snap Ship parts, UJU tech is a flexible material for more creative connections.



Watch Action-Packed Videos!



## **CLAYMORE** CR-76 COMBAT TRANSPORT

Claymore is designed to breach enemy defenses and drop off multiple mech land units for ground battle. Heavily armed, Claymore boasts enough firepower to wipe out entire squads of Komplex ground troops while also serving multiple mechs in its internal bays. With Claymore, you'll have:

- **STV-TERRIER** bipedal piloted assault mech
- **AP-64 BIPED MECH DRONE**, an AI-driven bipedal assault drone
- **SDU120 GOLIATH ENGINE**—mega powerful!
- **STRUCTURAL CHASSIS** for larger builds

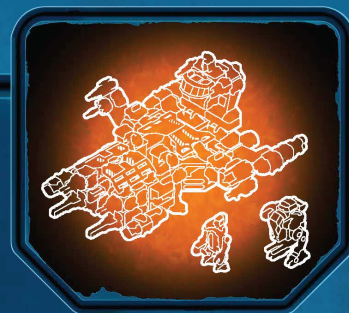

## **WHICH UJU TECH WILL YOU FIND?**

There are four powerful UJU tech pieces for you to find—how will you use them to maximize your ship's capabilities?

Are you ready to **BUILD TO BATTLE?**

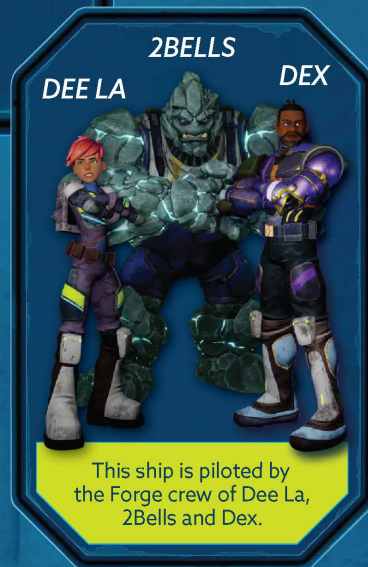

This ship is piloted by the Forge crew of Dee La, 2Bells and Dex.

Includes: 167 Building Pieces, 7 Accessories, 8 Projectiles, Instructions.  
Not every build will use every component—it's OK to leave some pieces in the hangar for later!



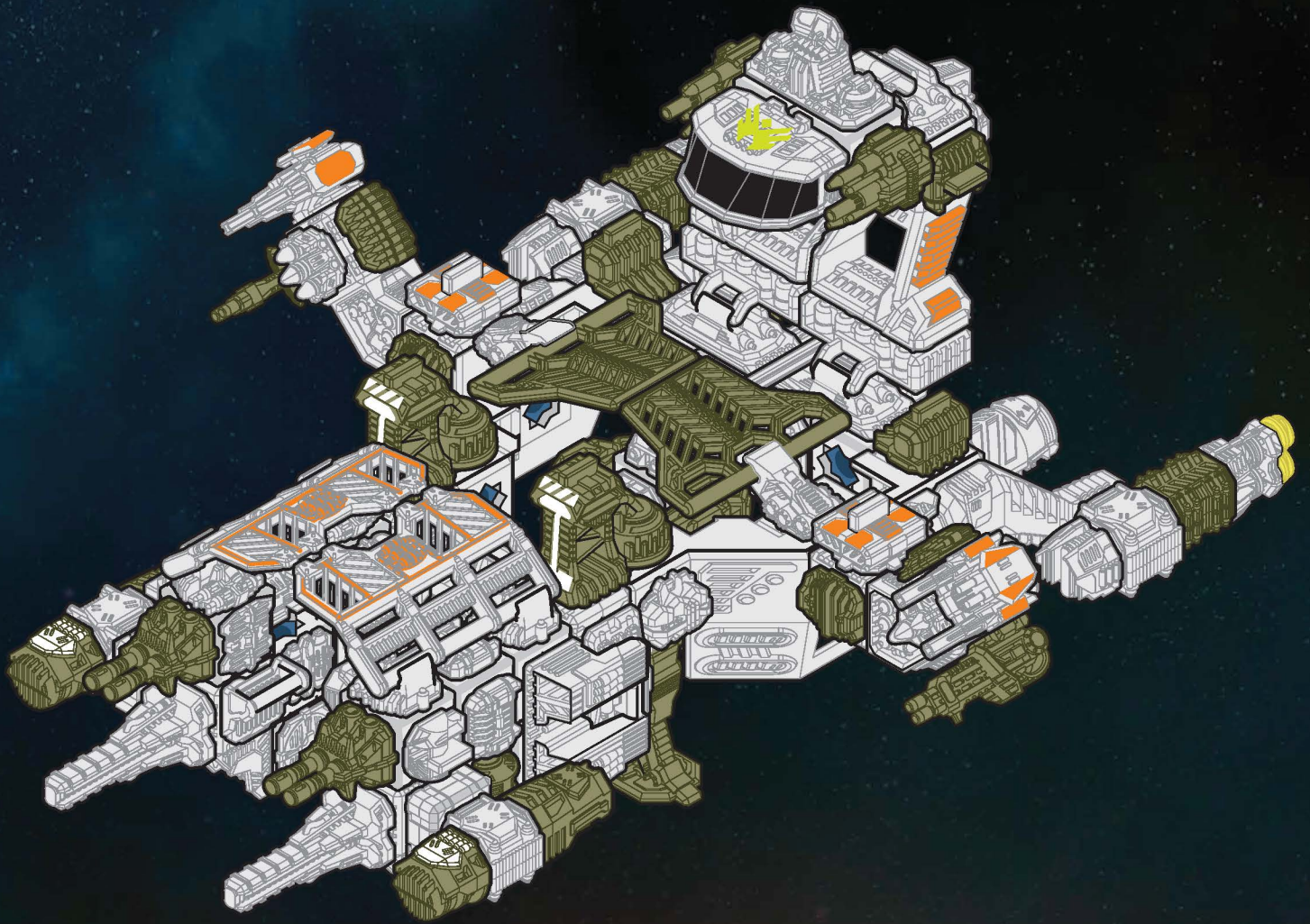

**CLAYMORE** CR-76  
COMBAT TRANSPORT





1

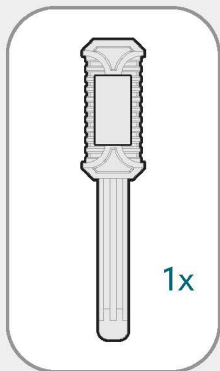

Separation Tool

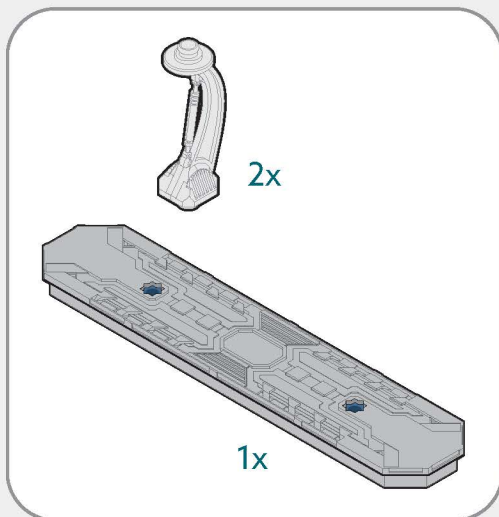
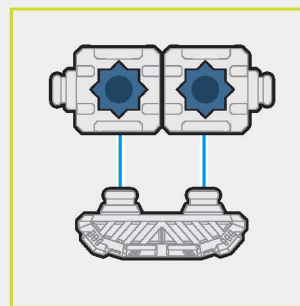
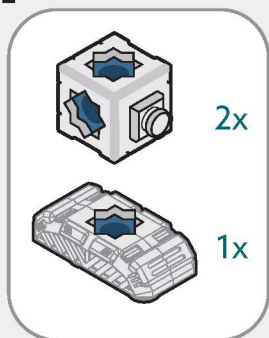
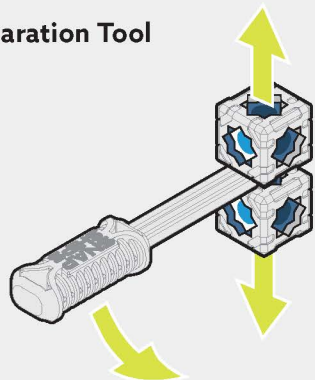

Box top is also a display stand. See P.62

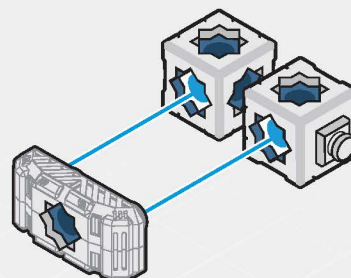

=

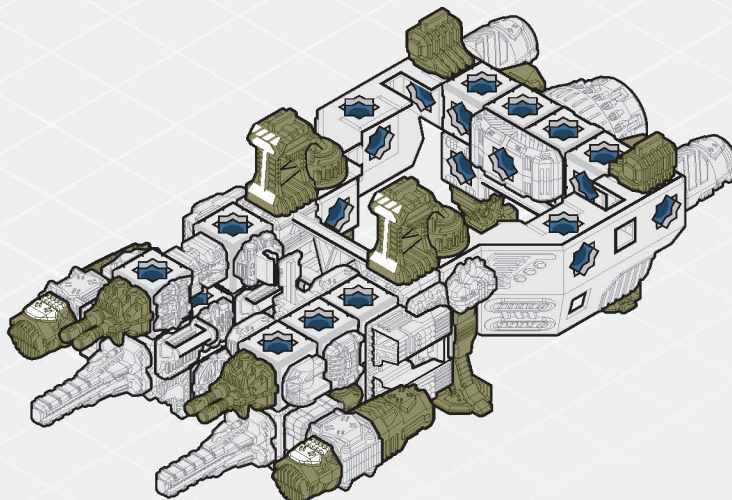

2

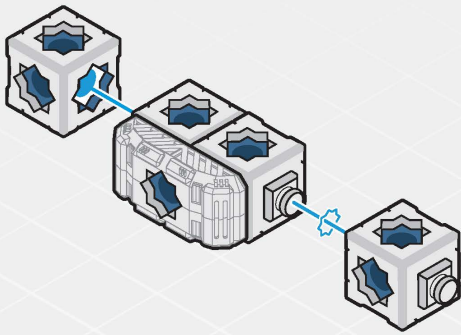
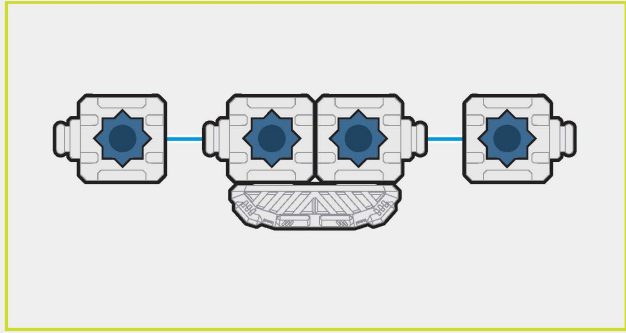

3

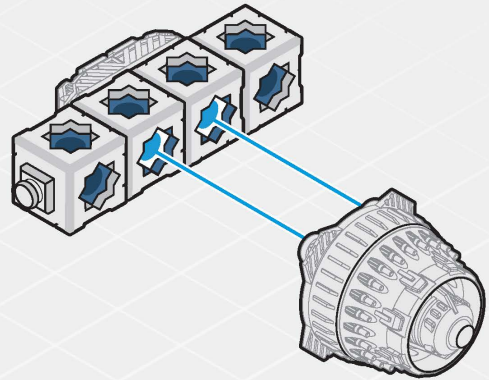
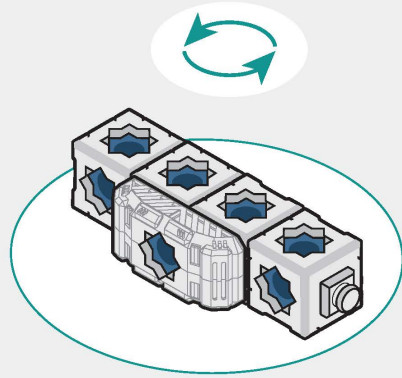
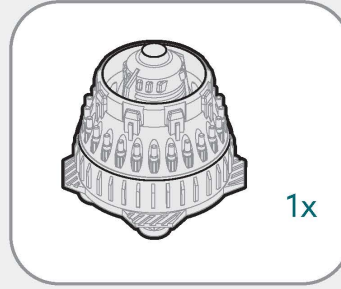



4

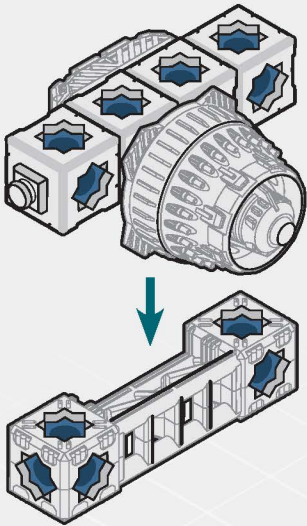
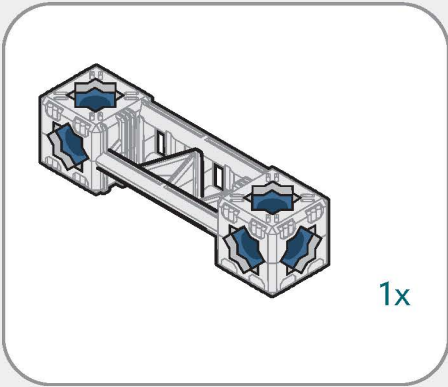

5

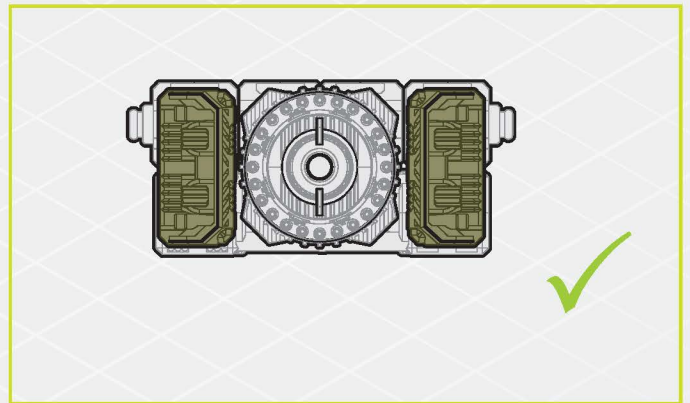
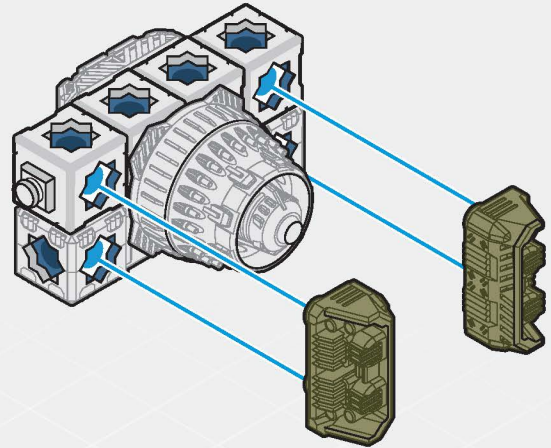
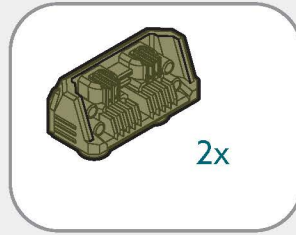

6

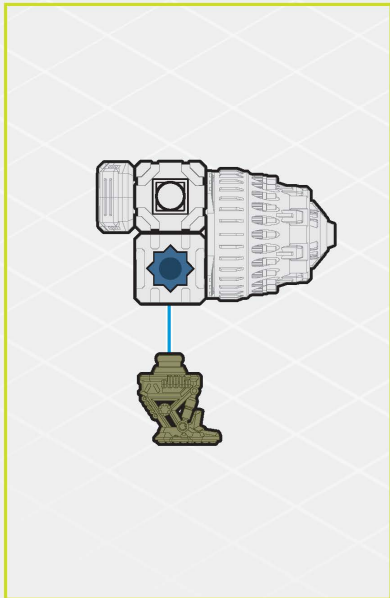
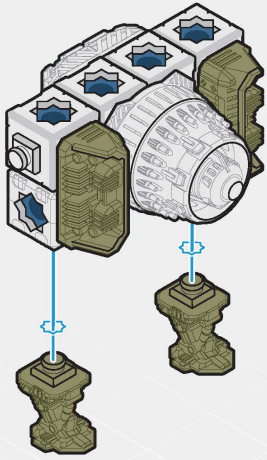
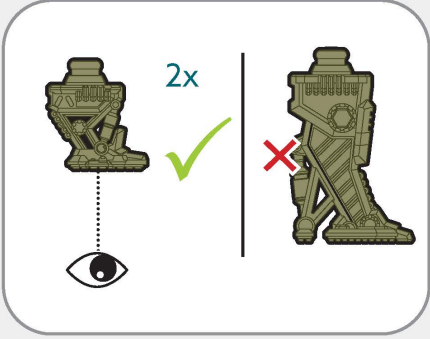

7

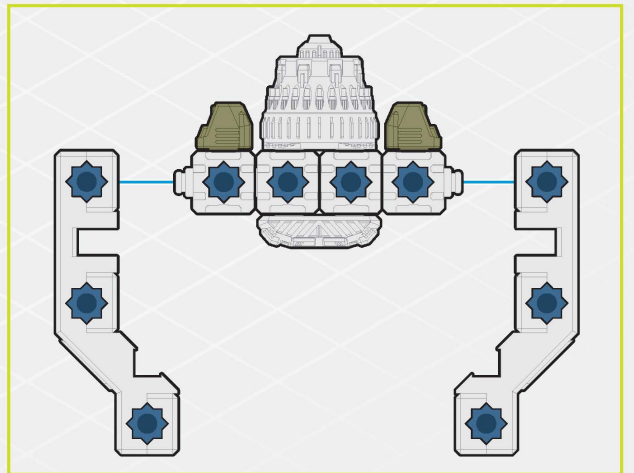
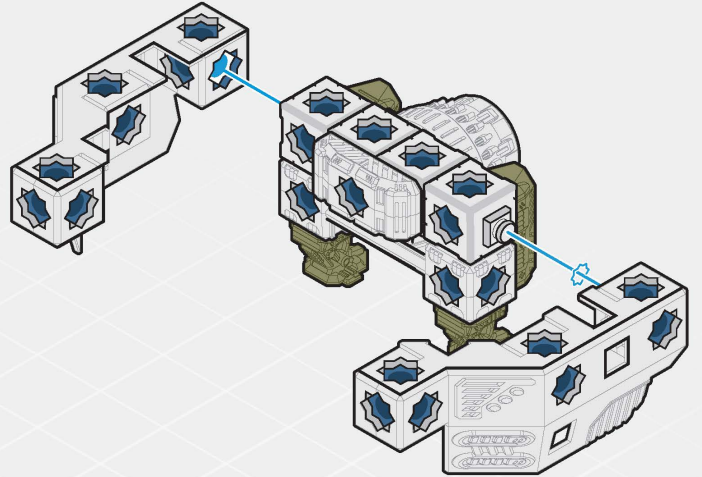
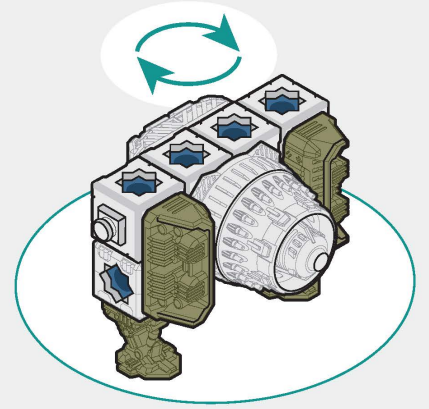
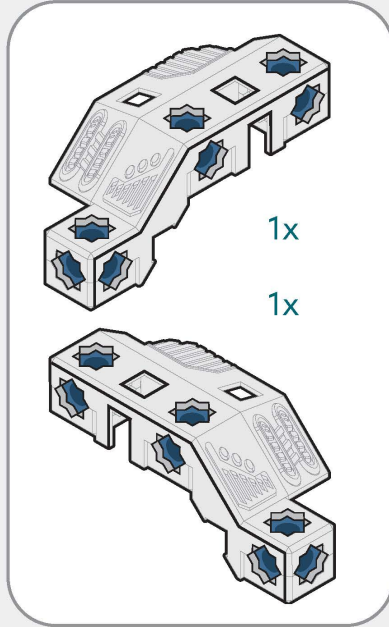



8

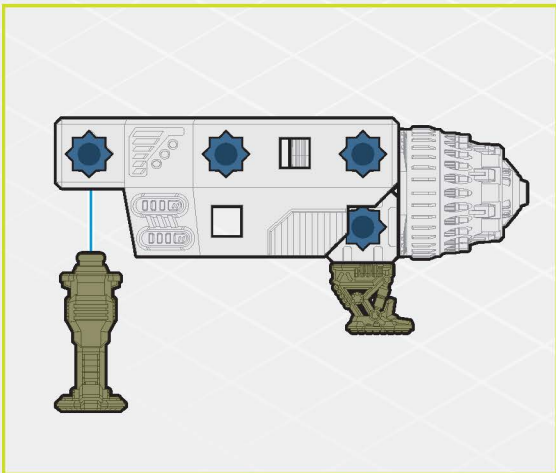
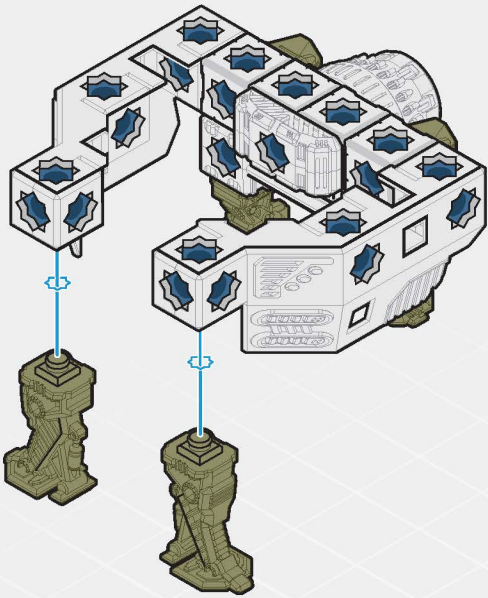

9

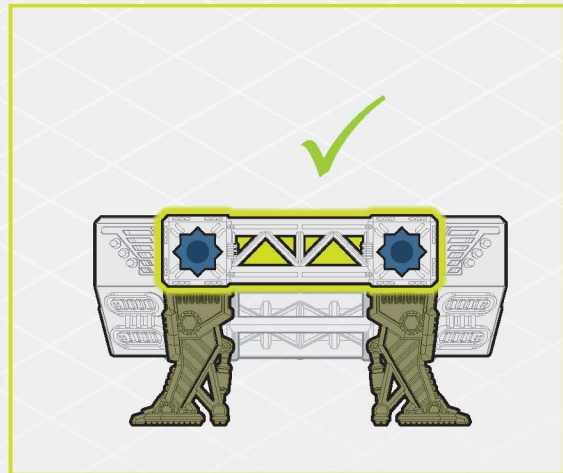
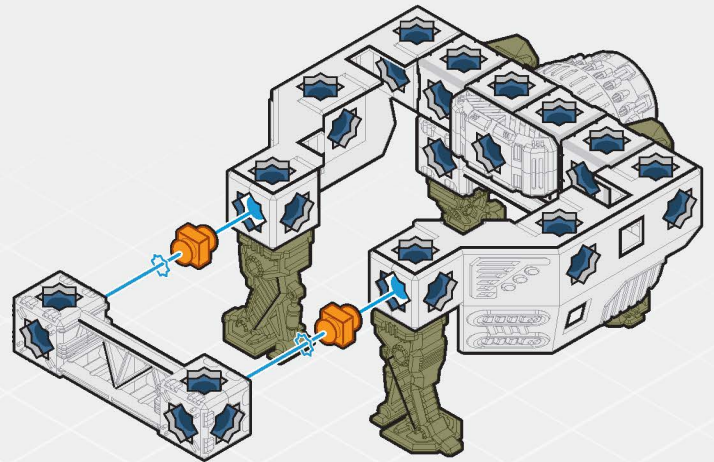
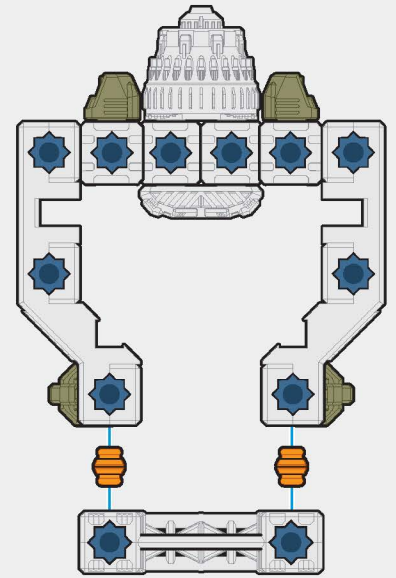
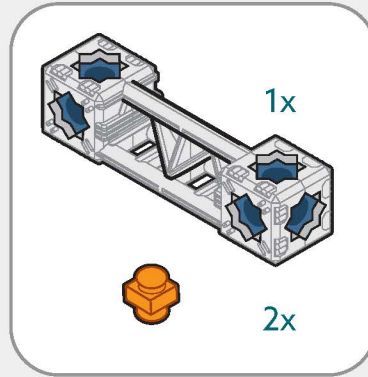

10

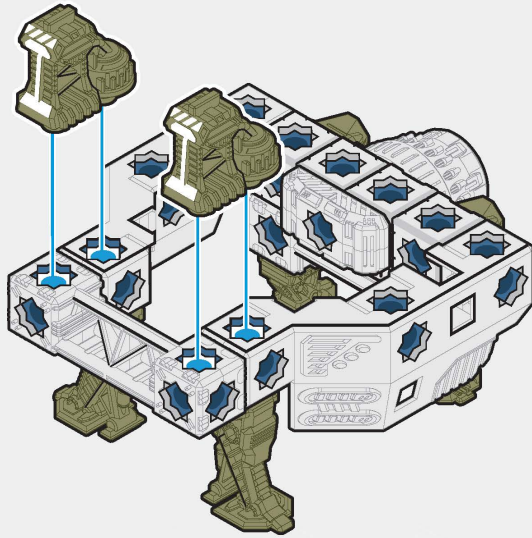
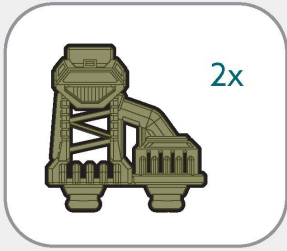

11

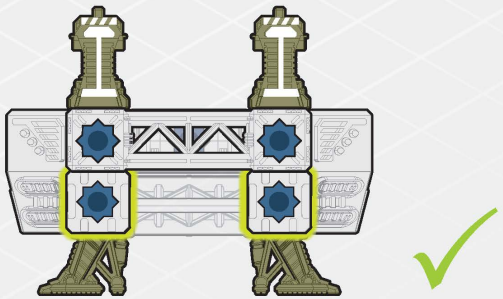
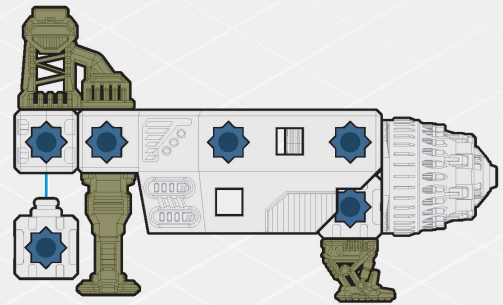
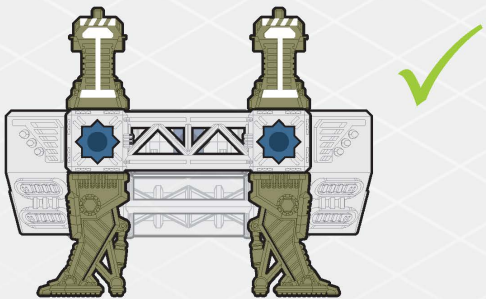
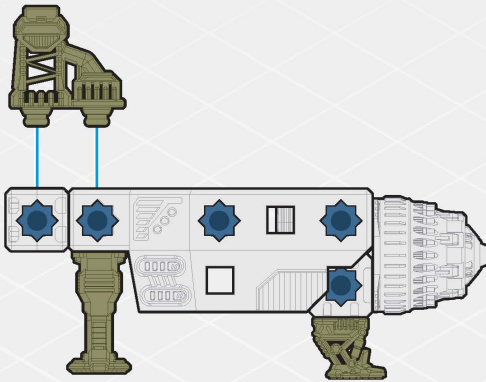
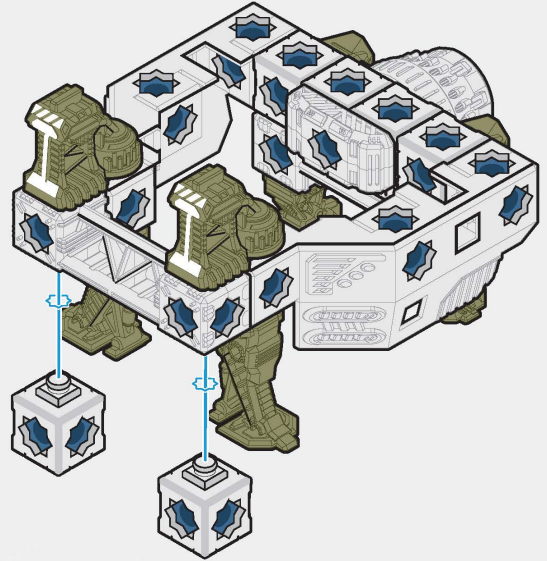



# 12

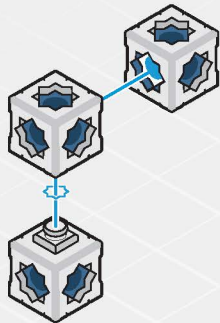
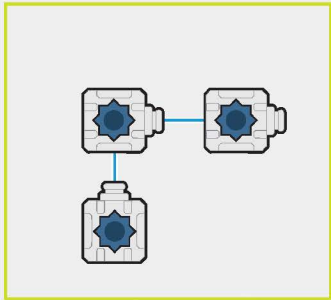

# 13

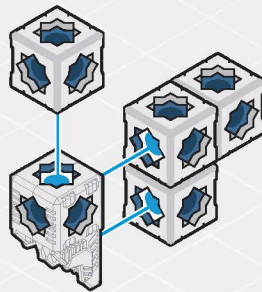
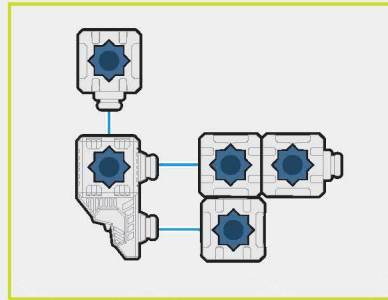
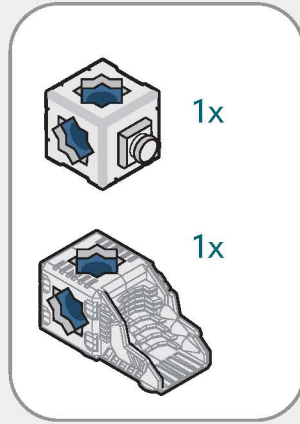

# 14

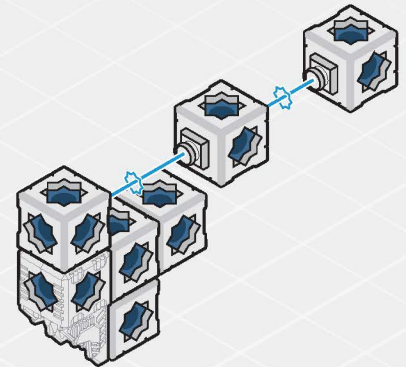
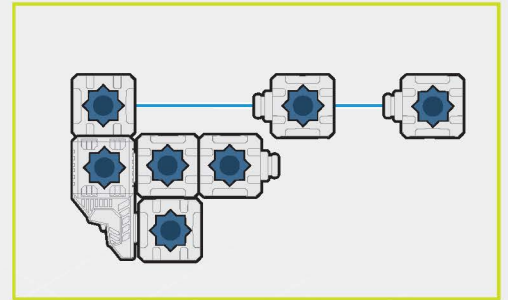

15

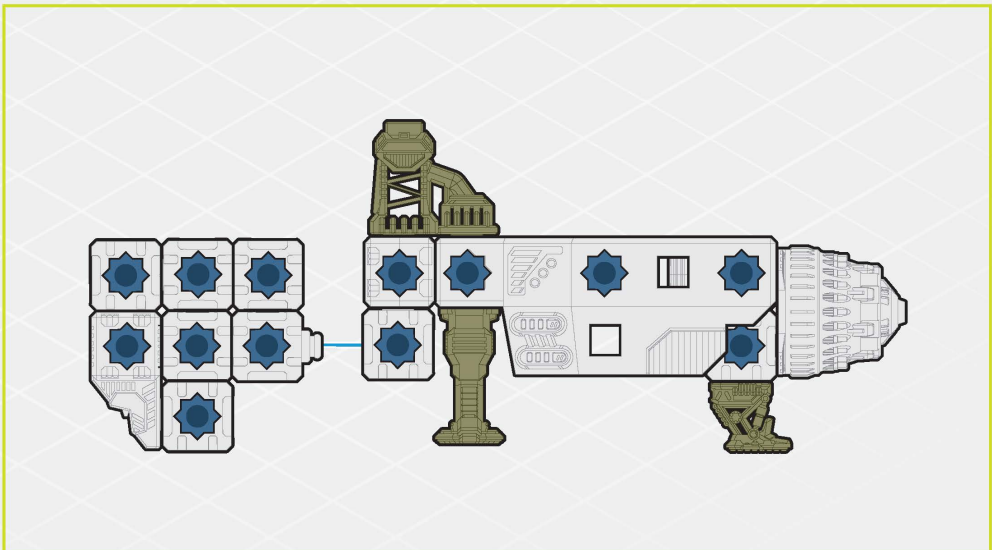
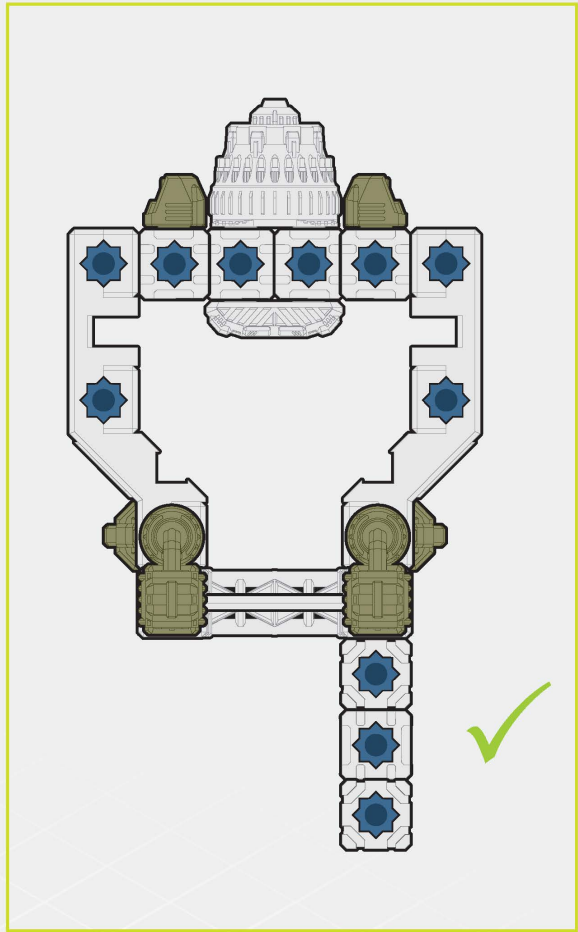
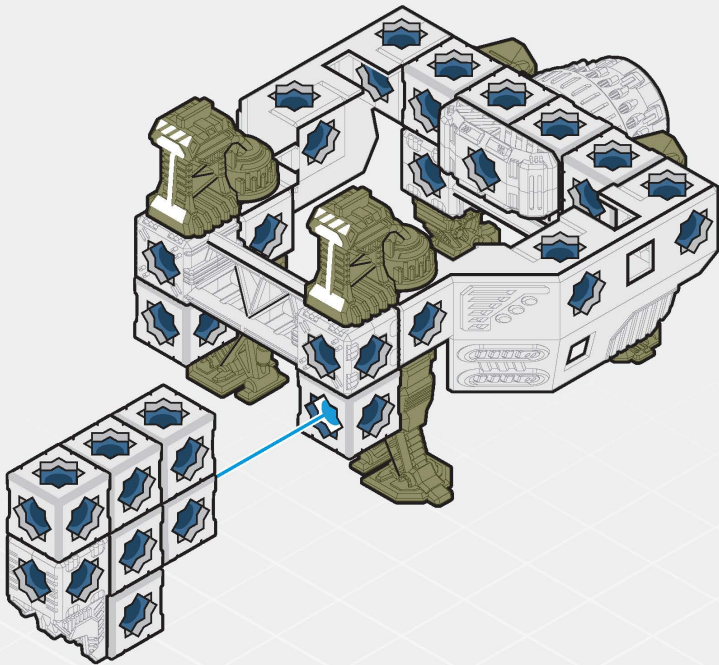
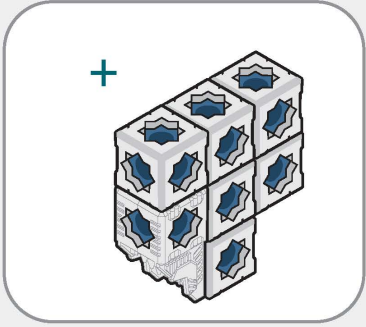



# 16

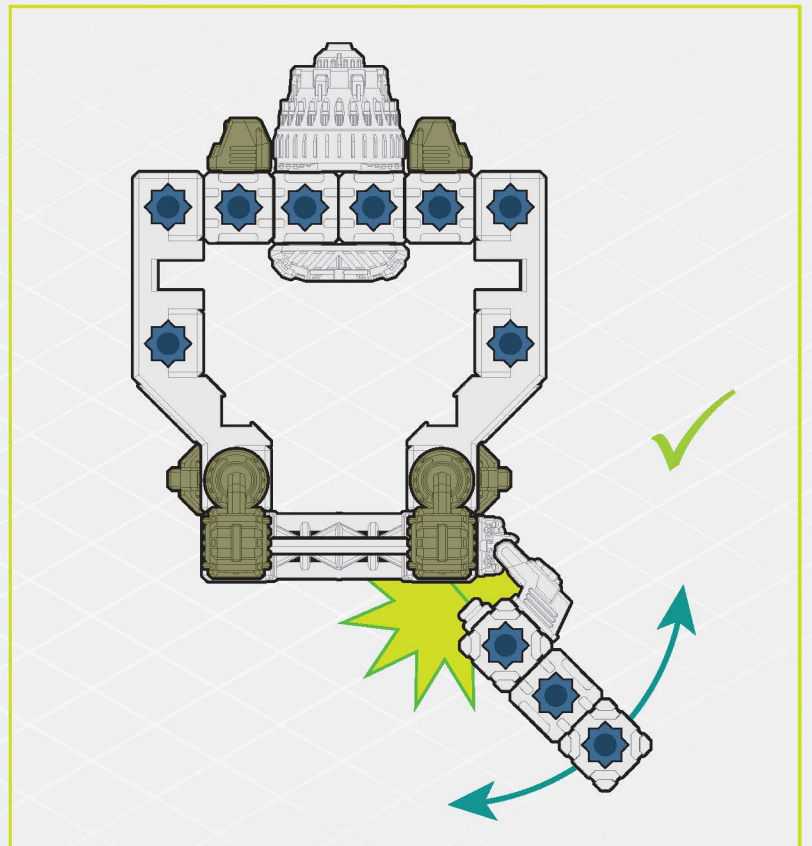
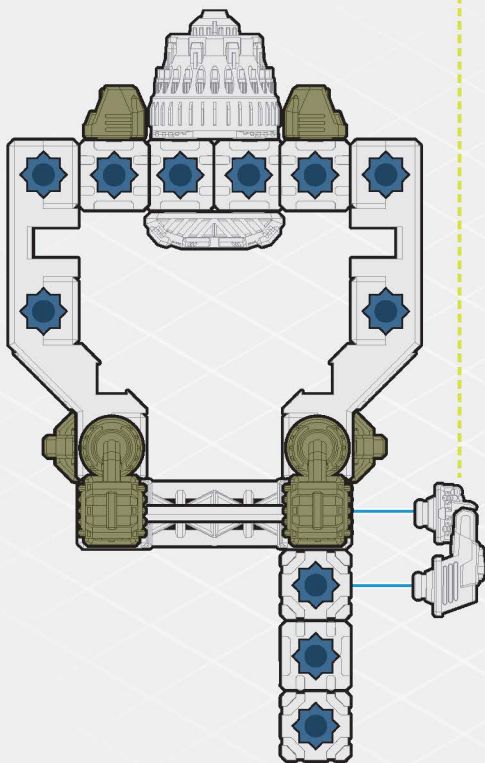
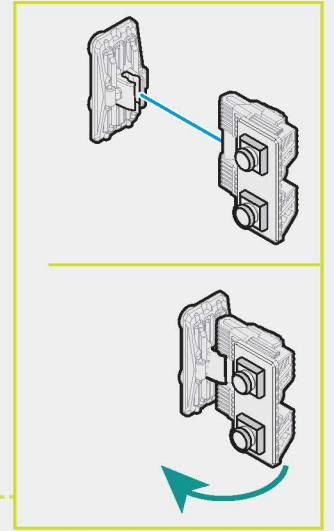
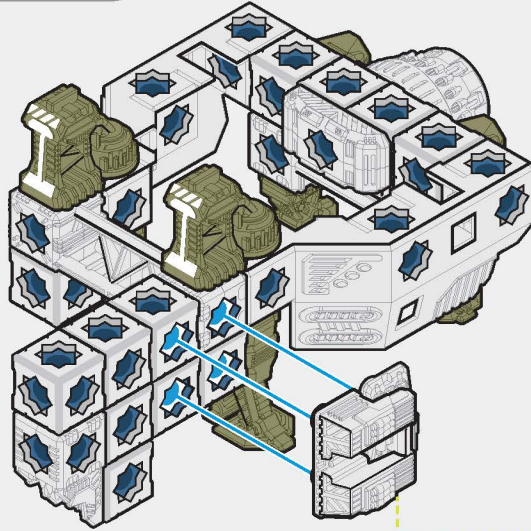
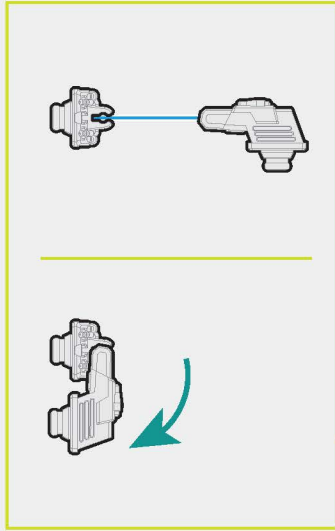
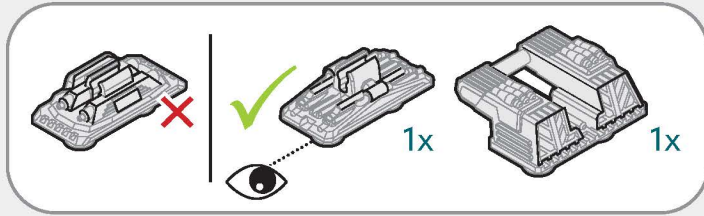

# 17

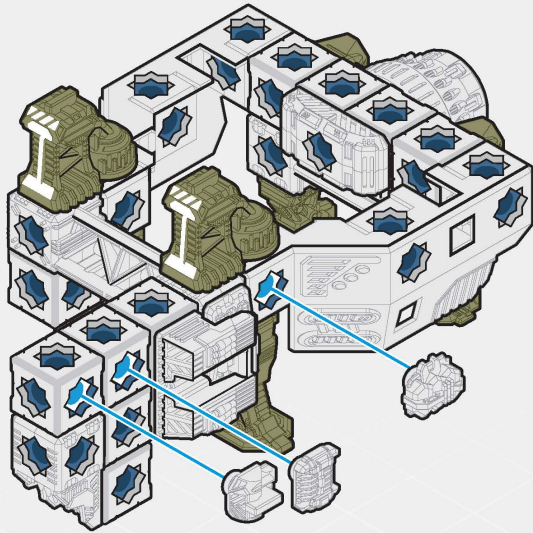
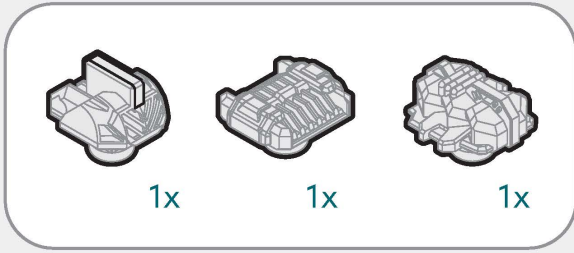

# 18

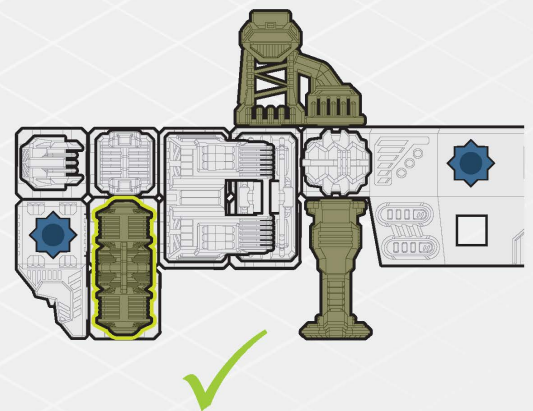
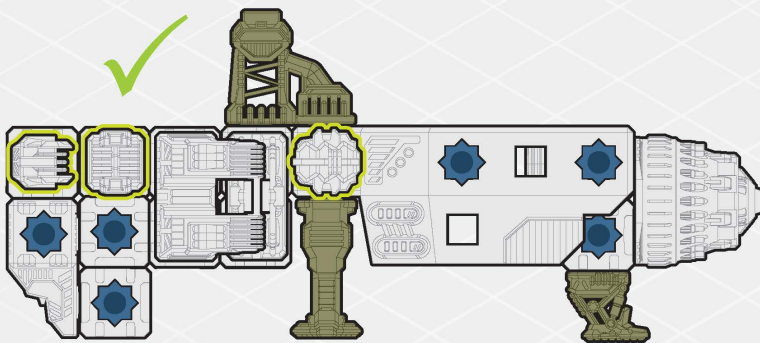
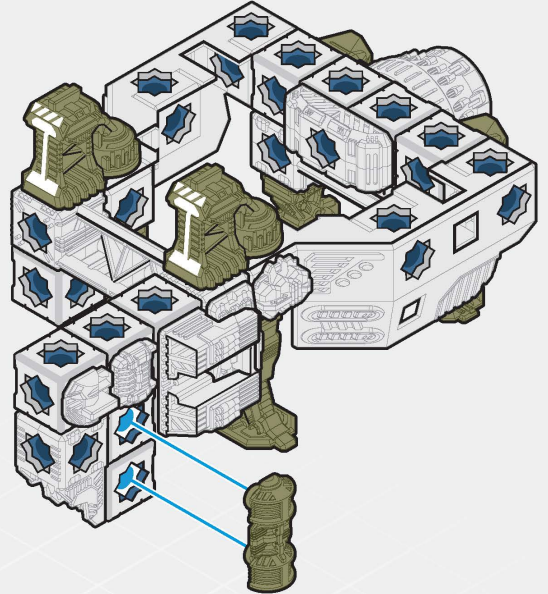
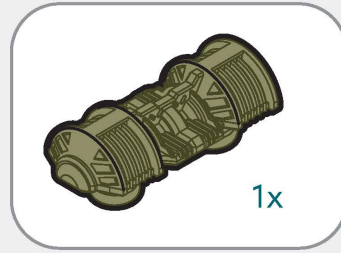



# 19

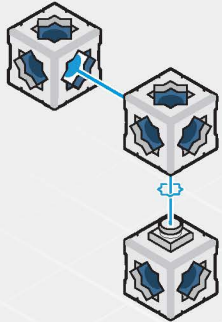
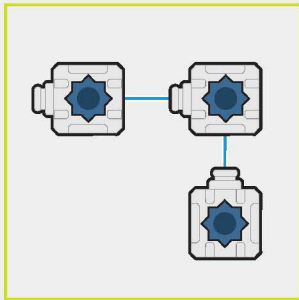

# 20

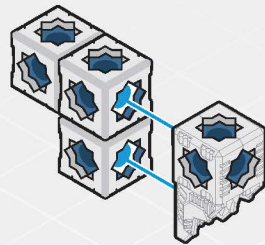
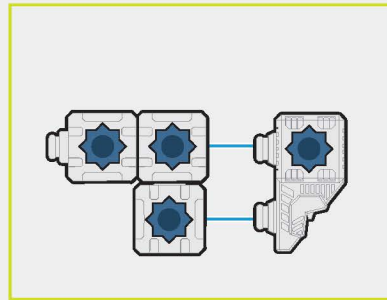
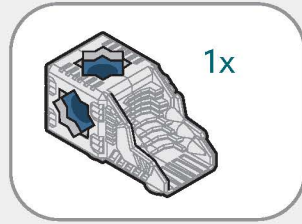

# 21

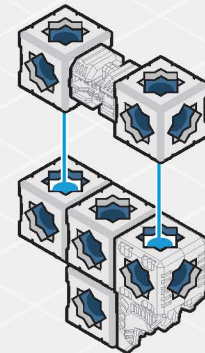
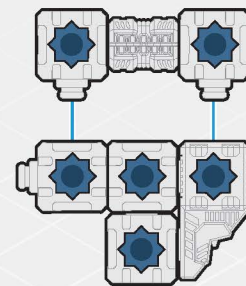
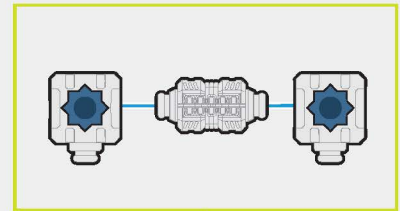
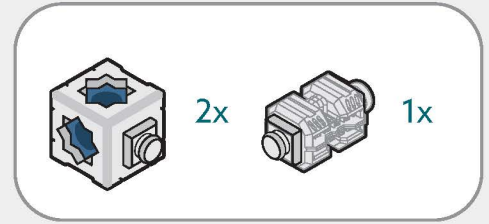

22

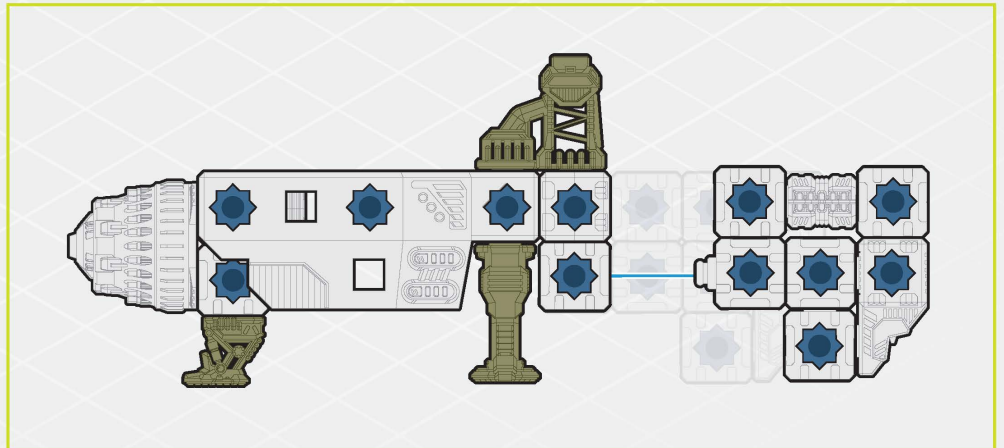
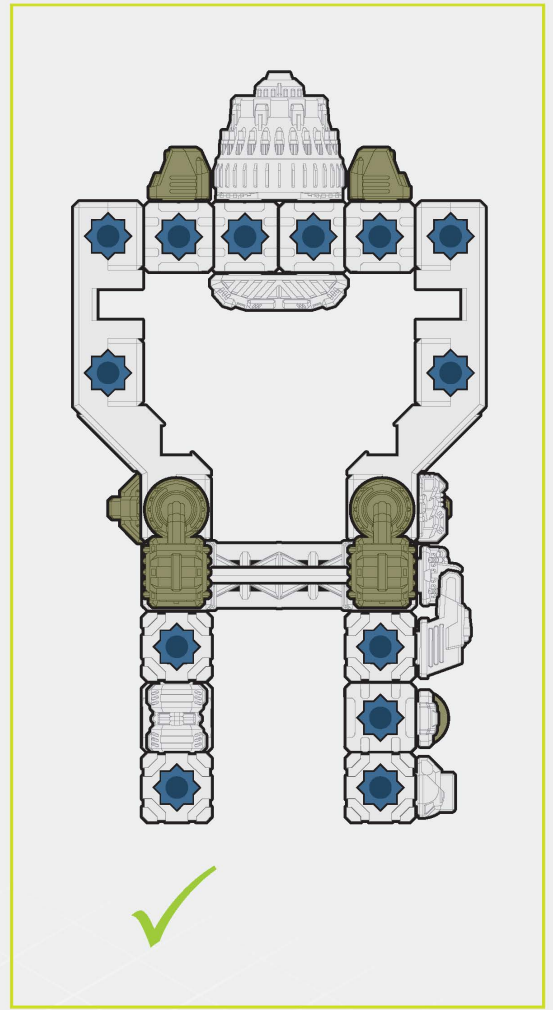
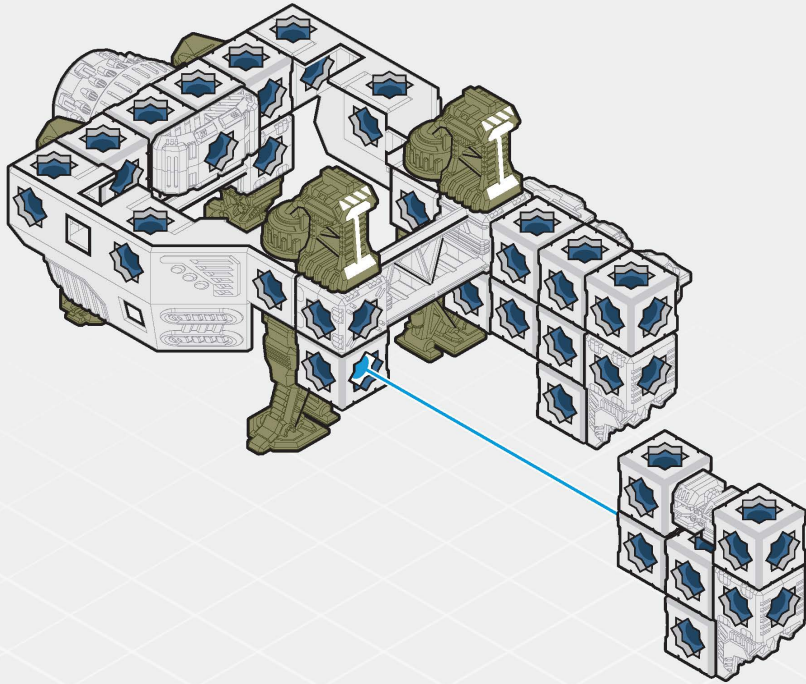
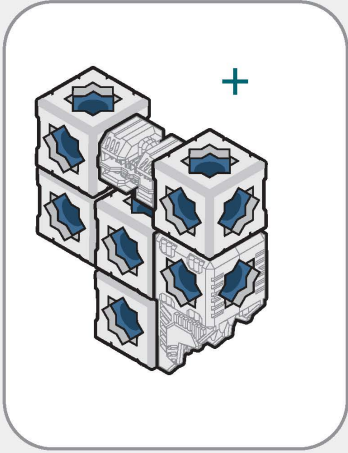



# 23

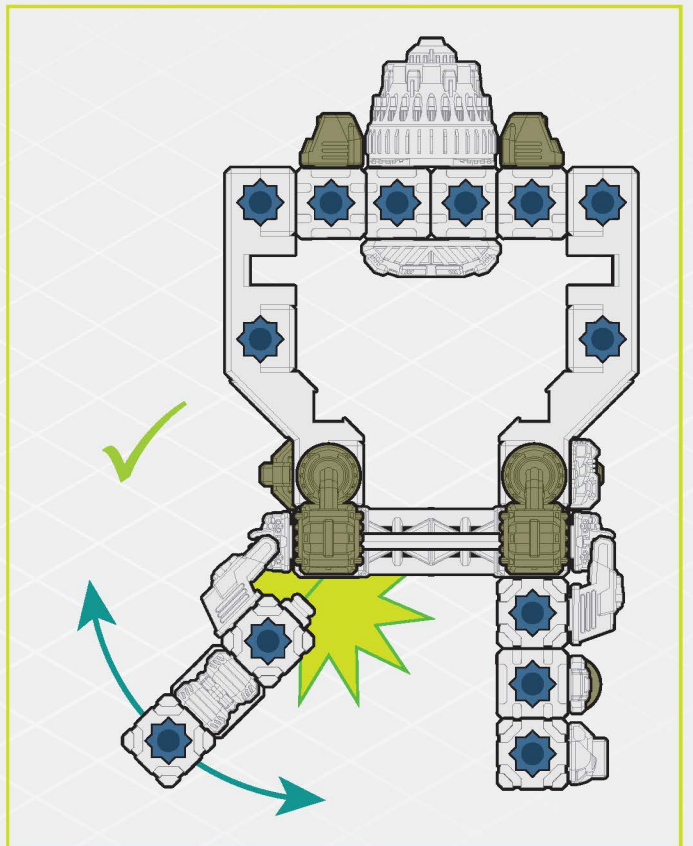
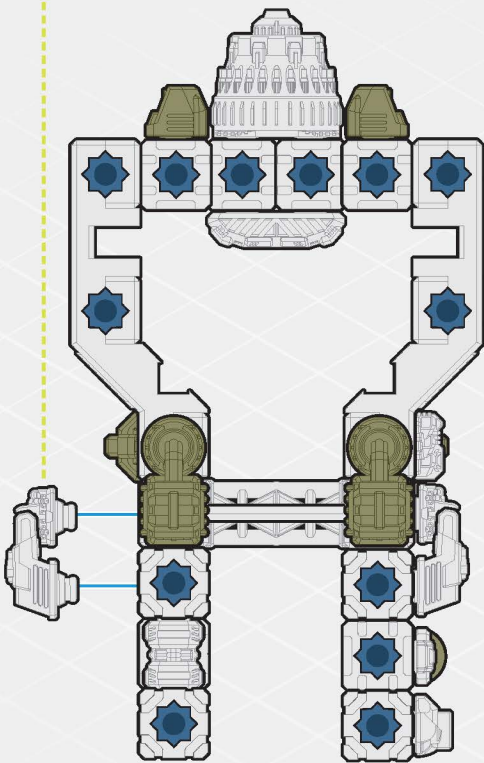
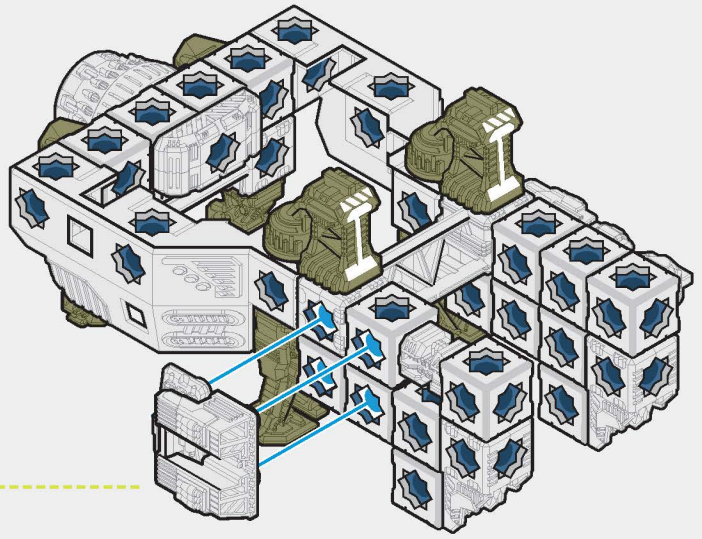
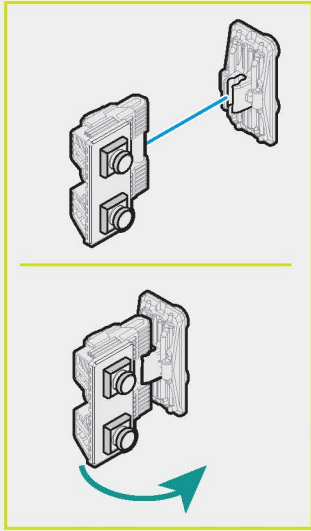
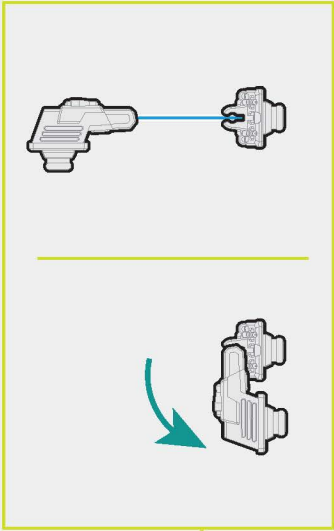
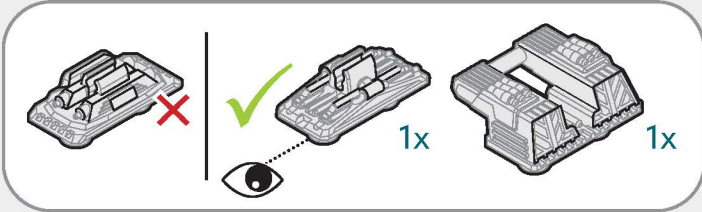

24

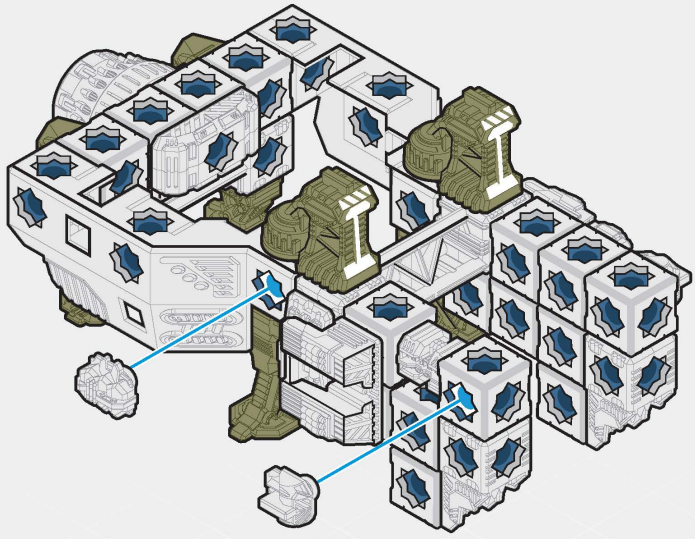
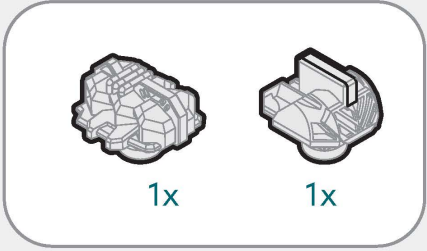

25

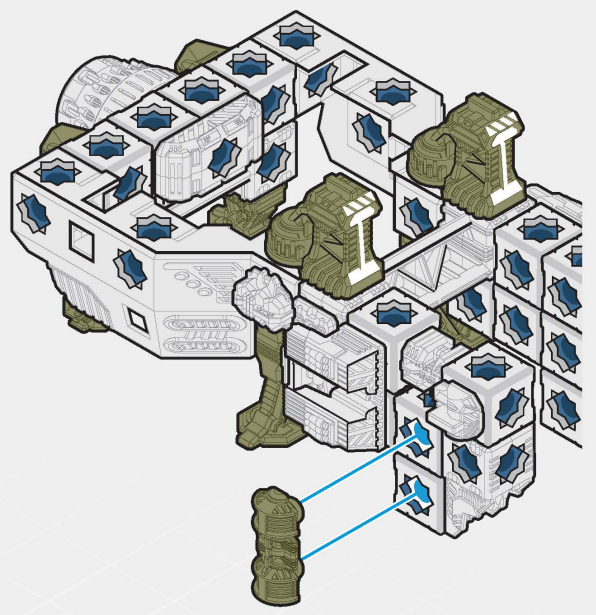
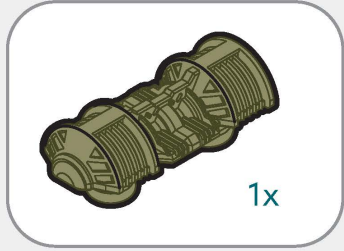

CLAYMORE CR-76 COMBAT TRANSPORT

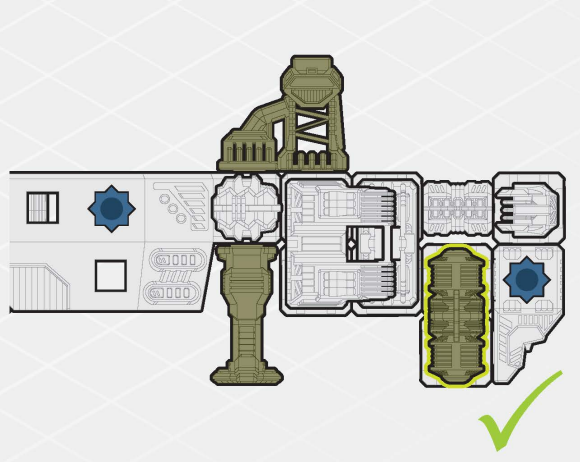
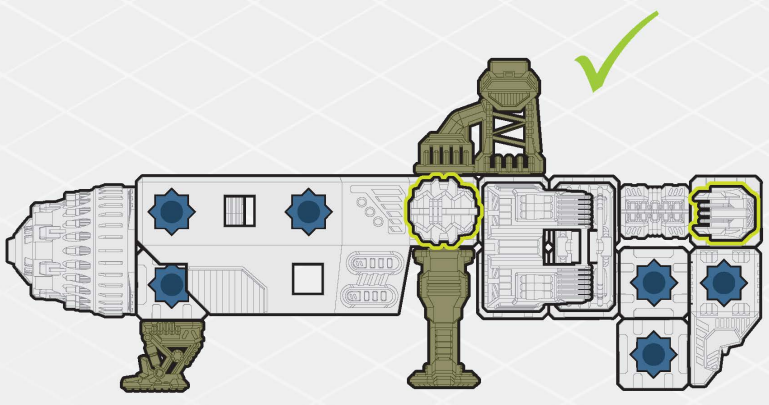



26

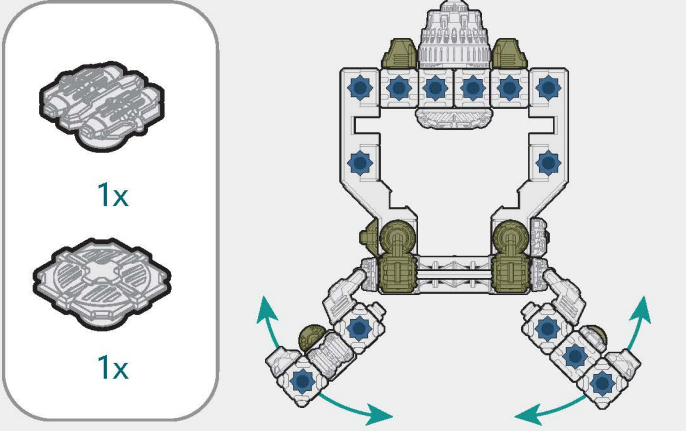

27

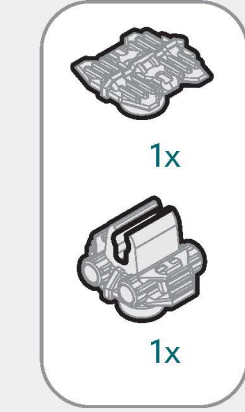

28

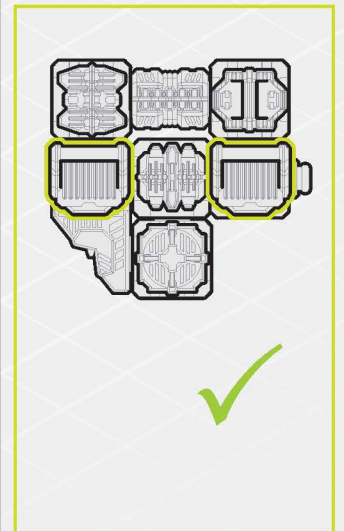
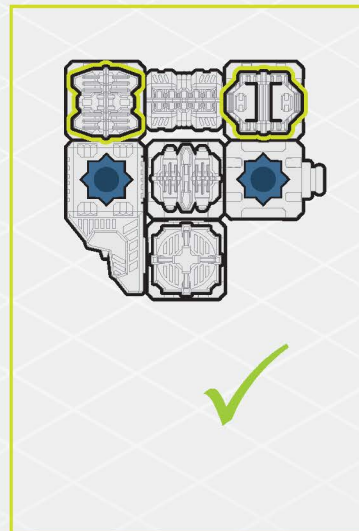
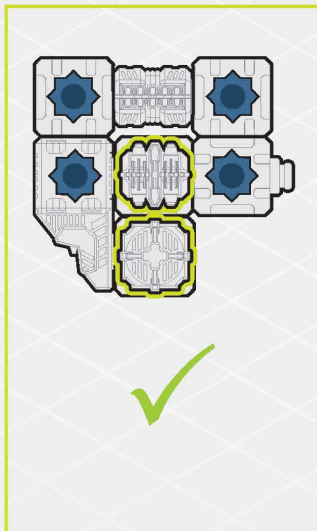
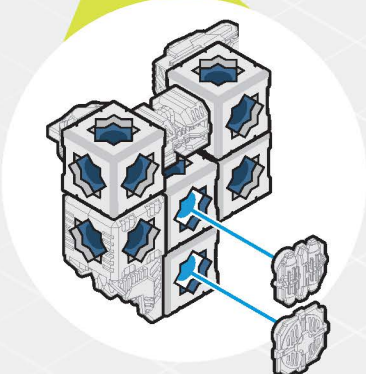
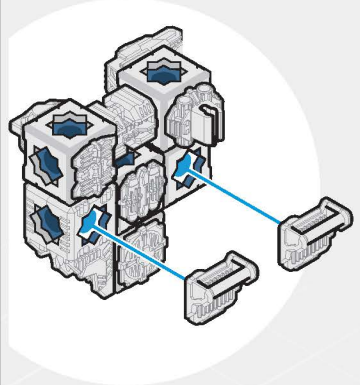
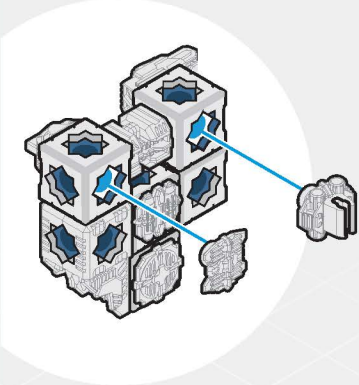
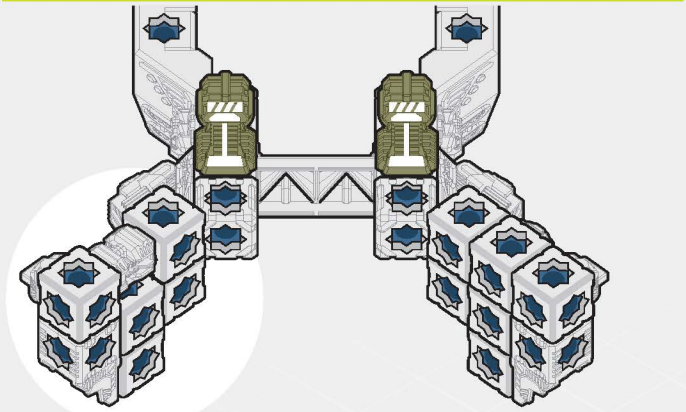
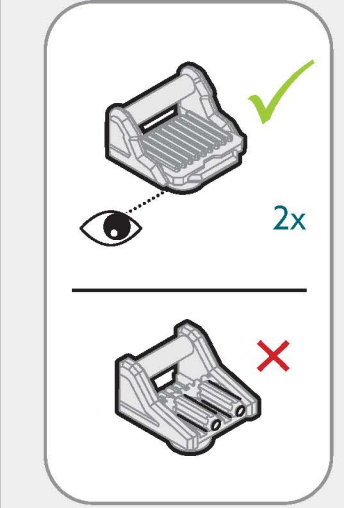

# 29

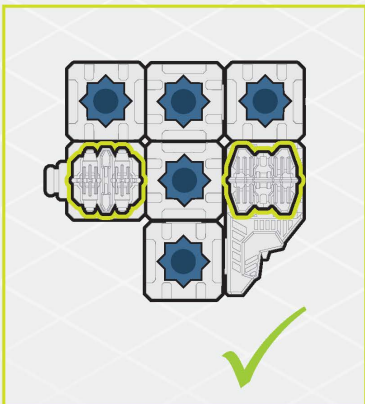
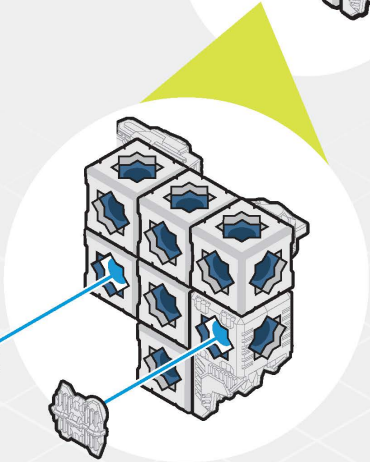
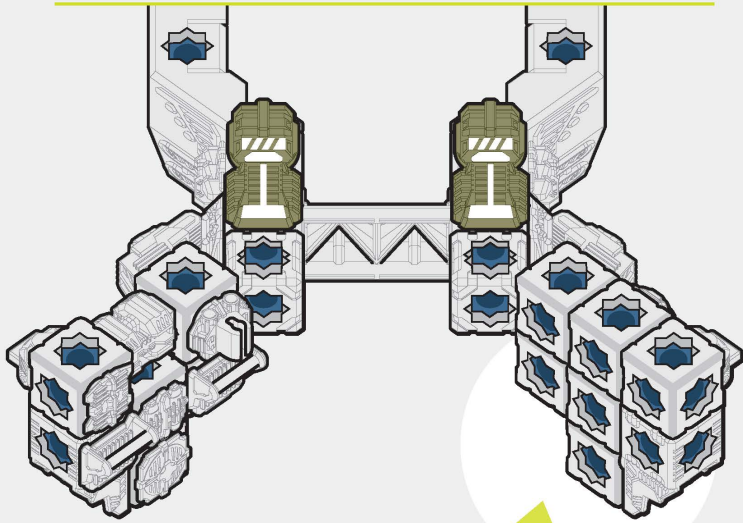
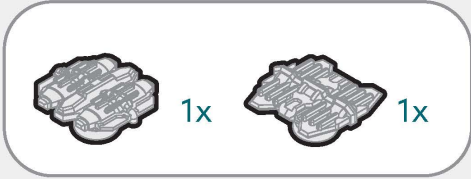

# 30

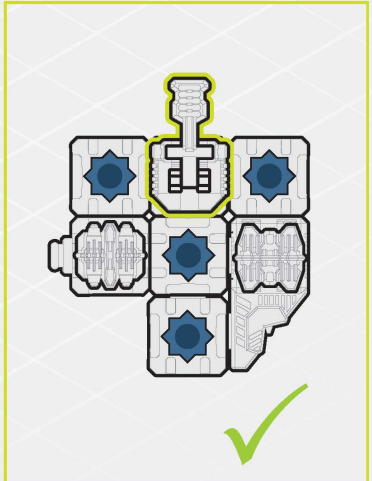
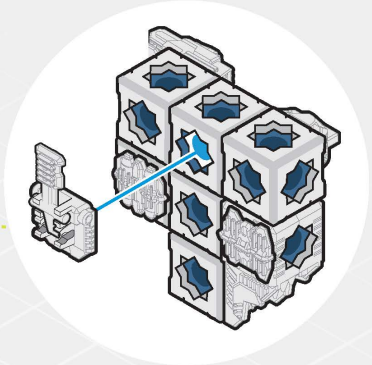
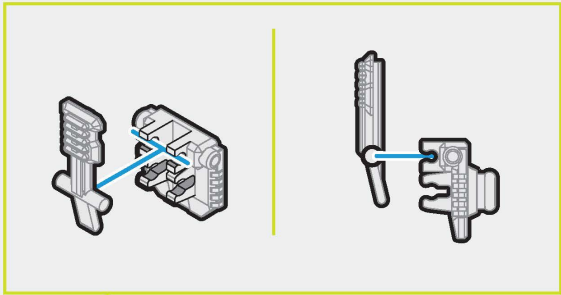
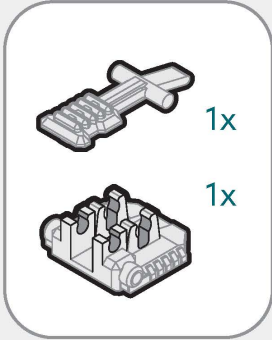



# 31

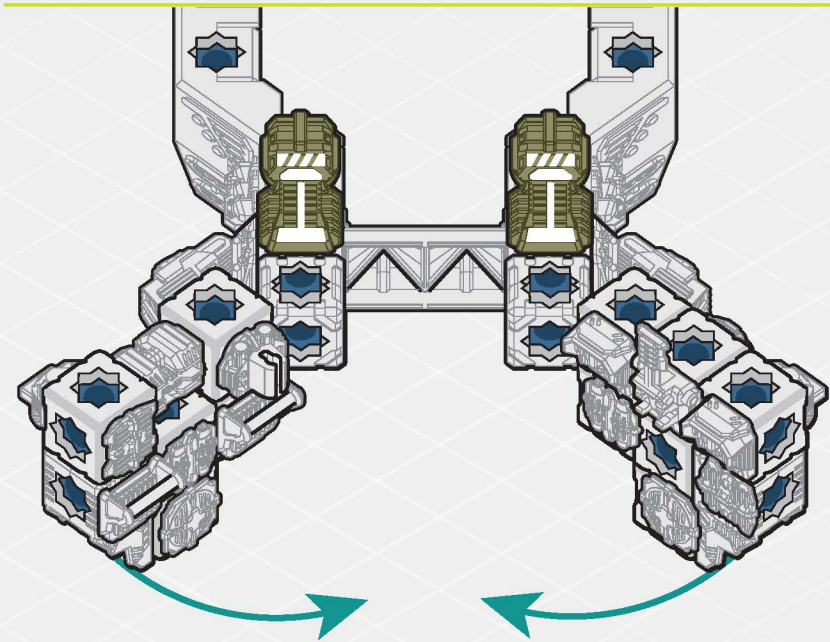
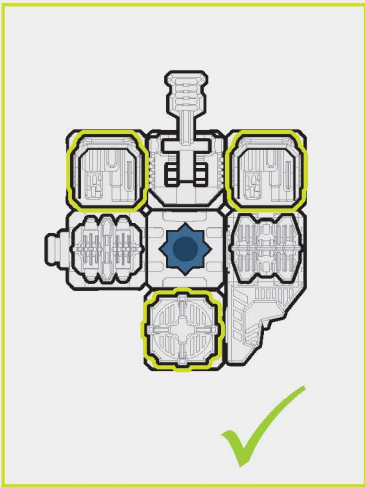
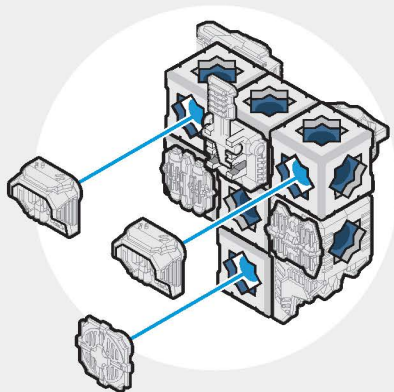
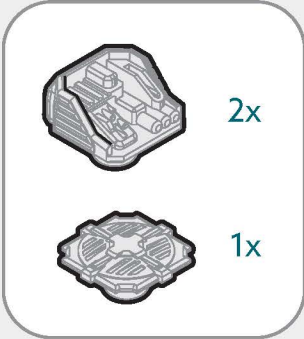

# 32

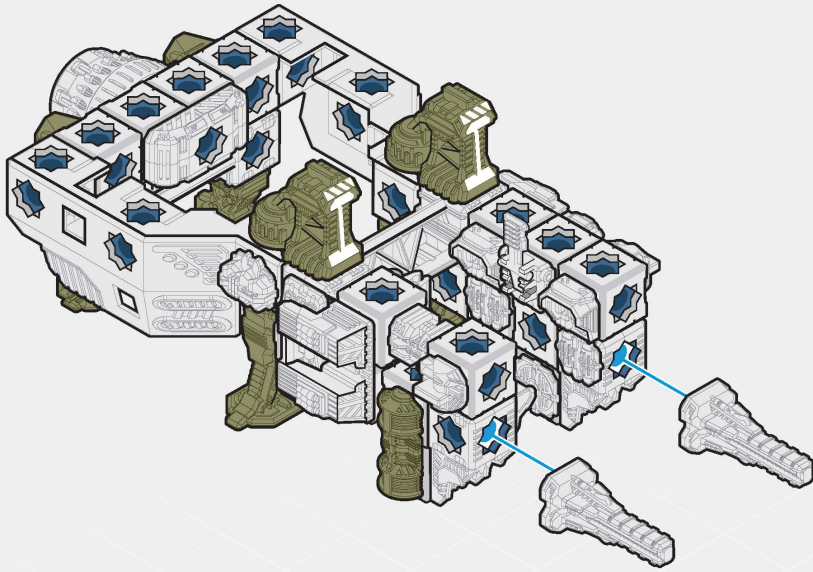
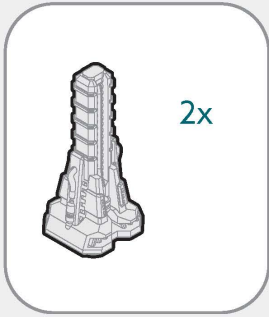

# 33

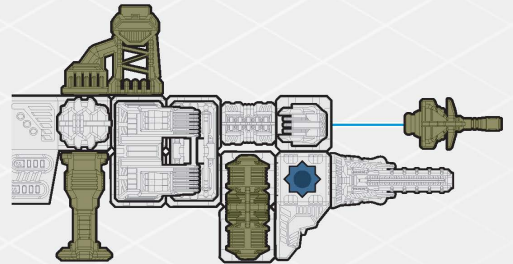
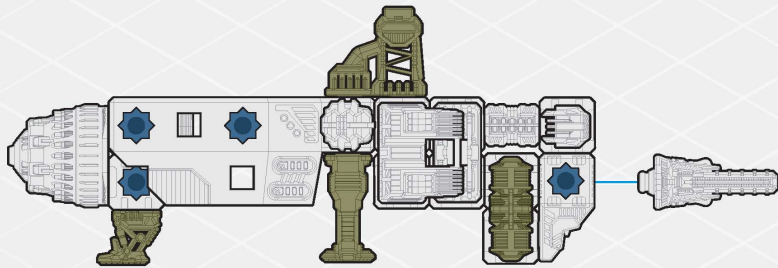
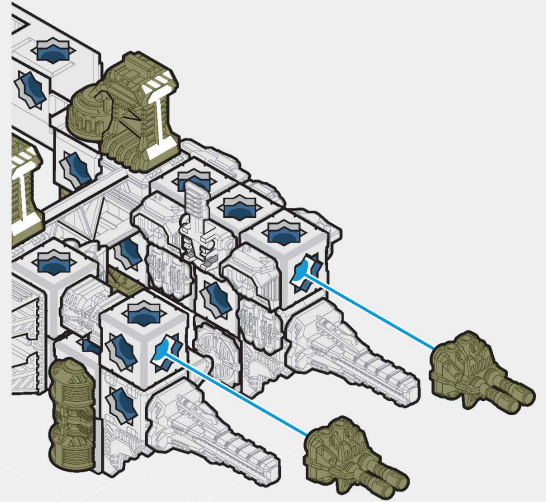
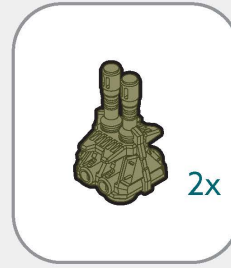

# 34



1x



1x



1x

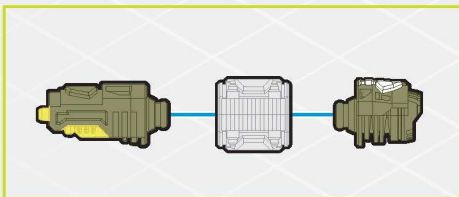
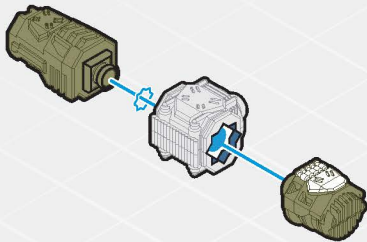
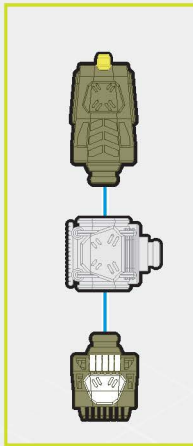

# 35



1x

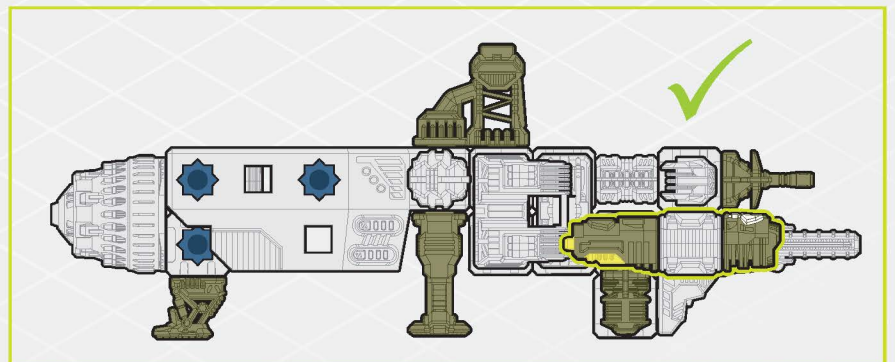
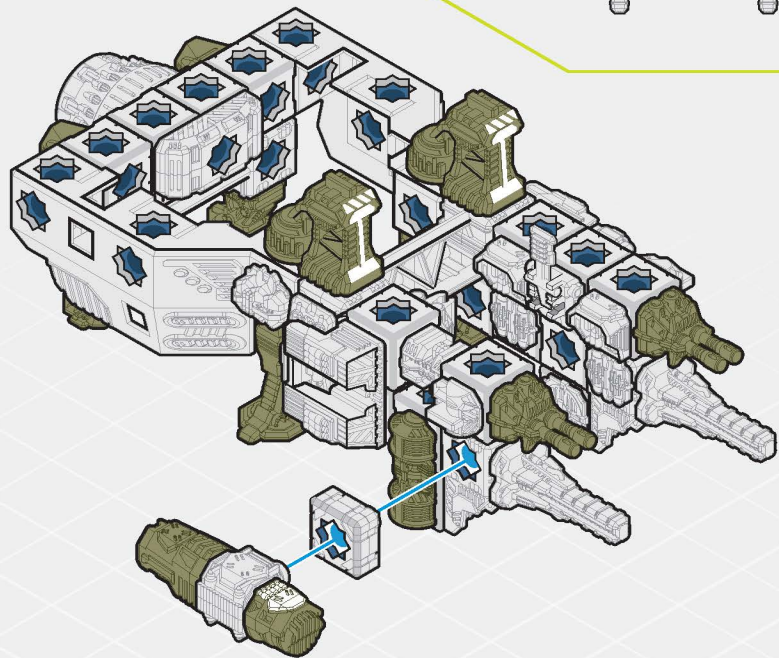
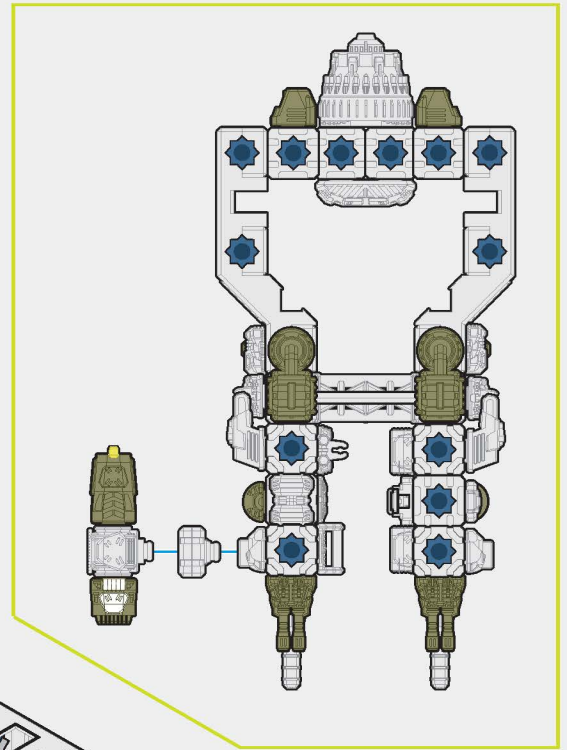



# 36

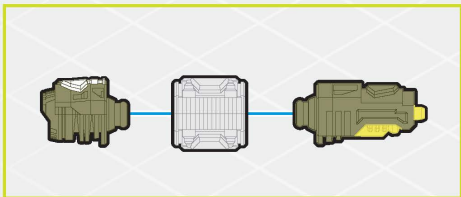
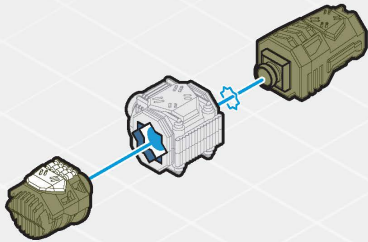
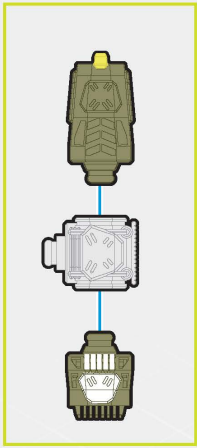
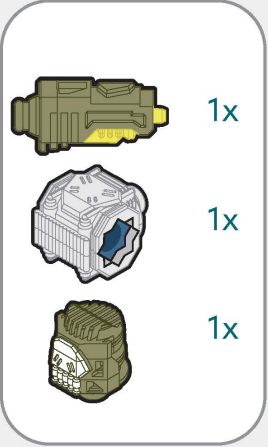

# 37

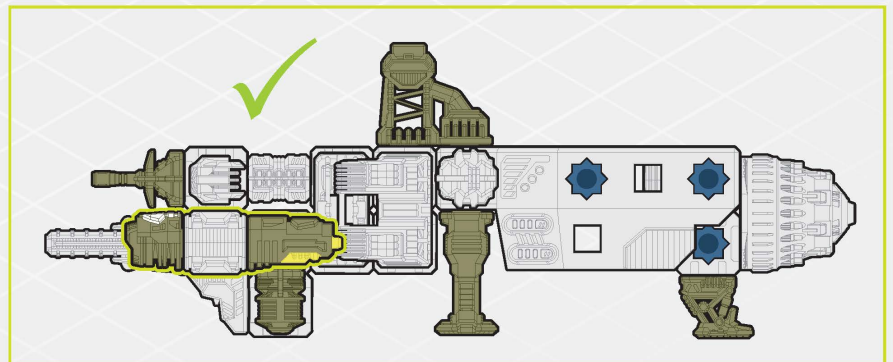
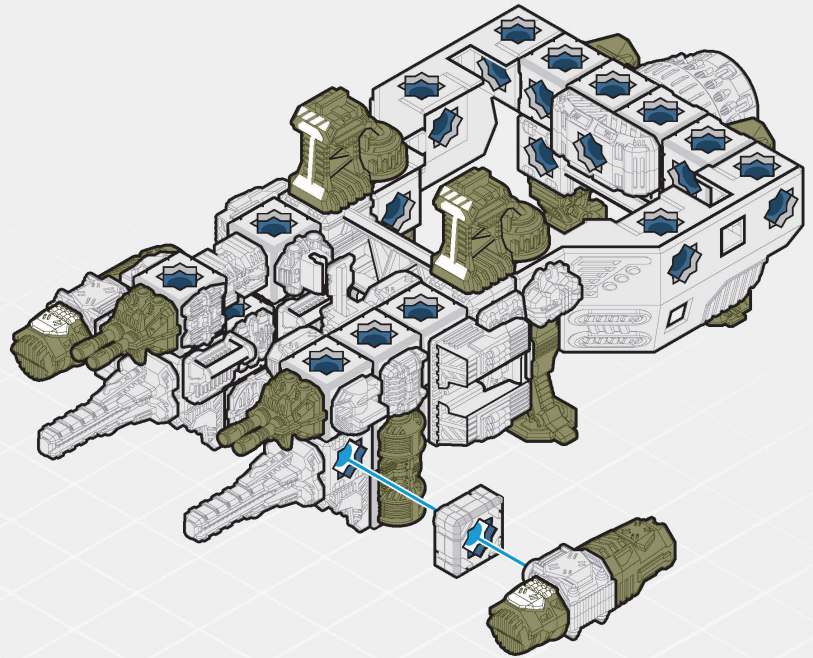
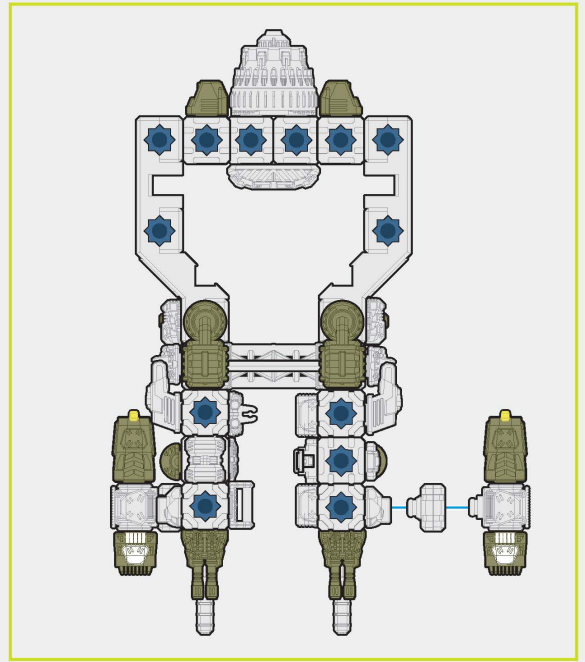
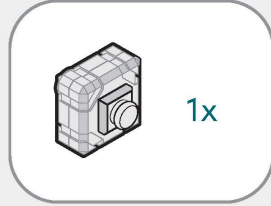

# 38

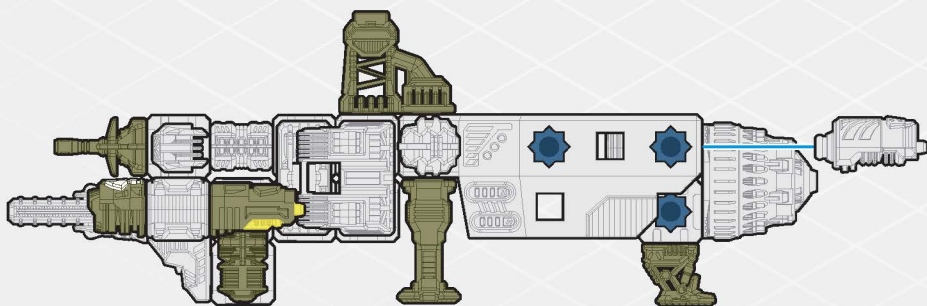
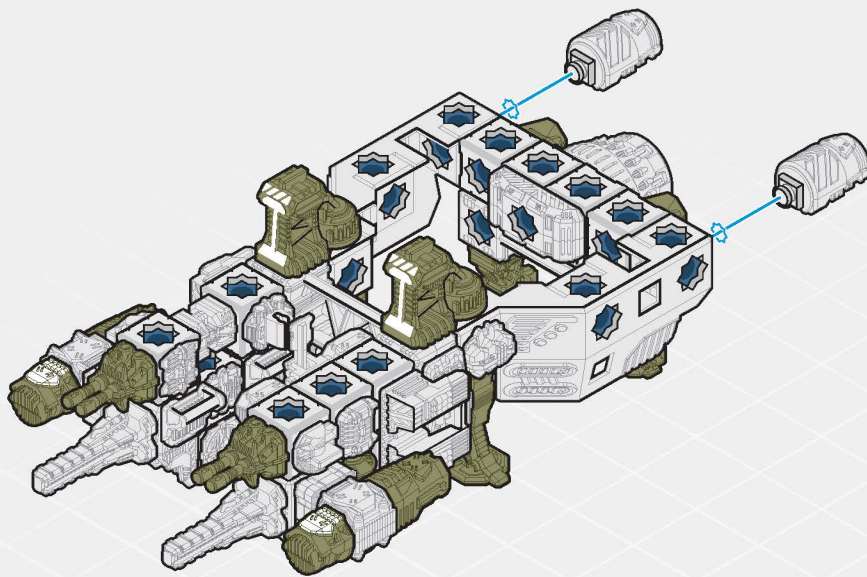
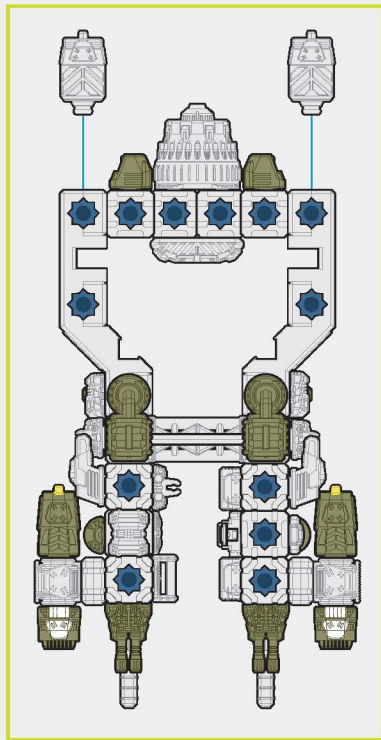

# 39

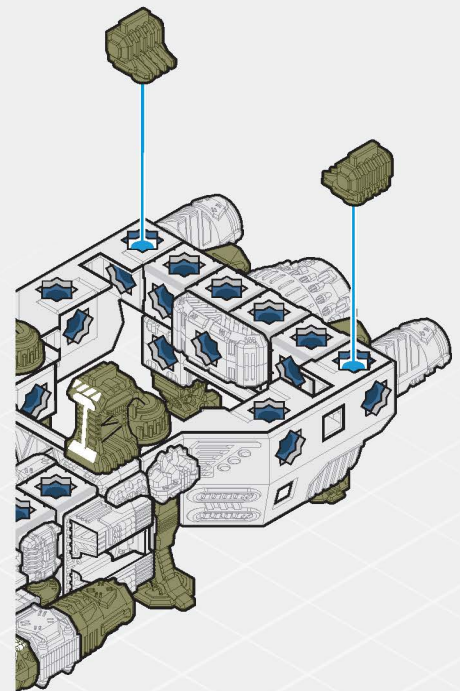
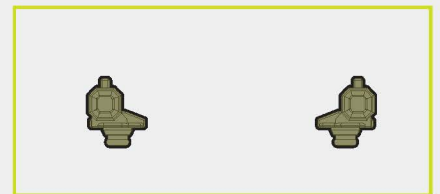







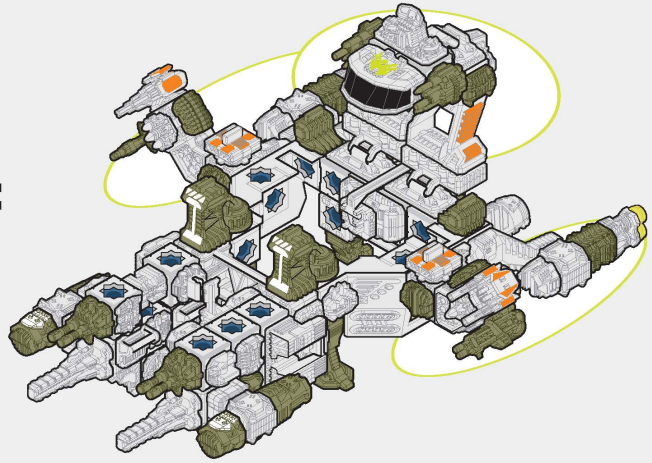

=

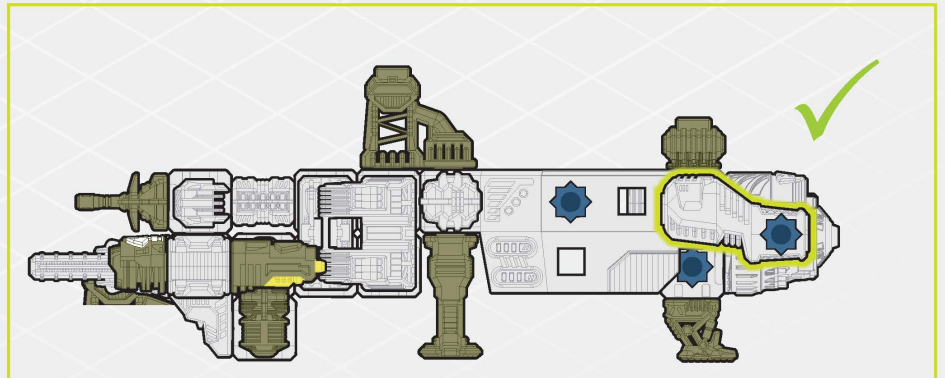
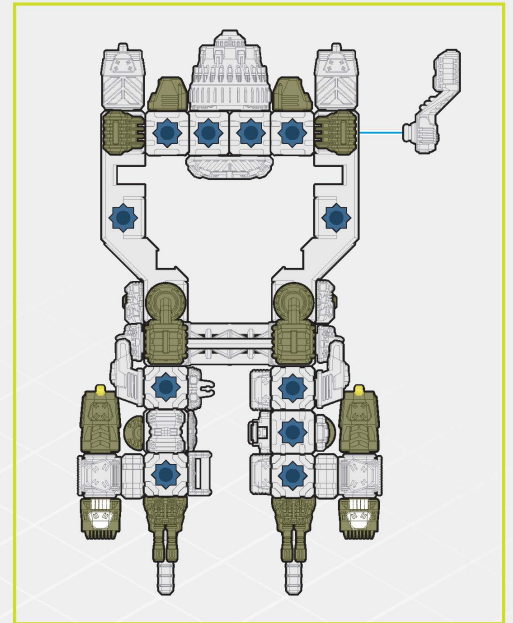
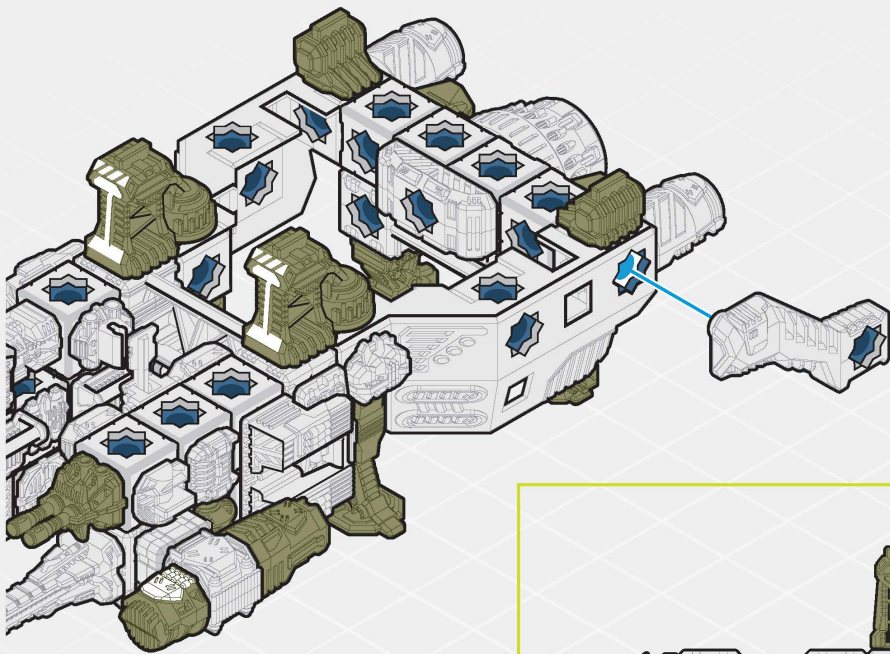
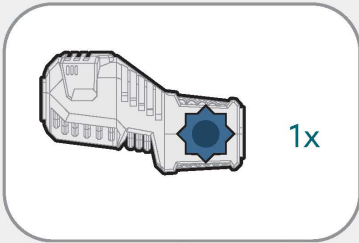

40



# 41

-  1x
-  1x
-  1x
-  1x

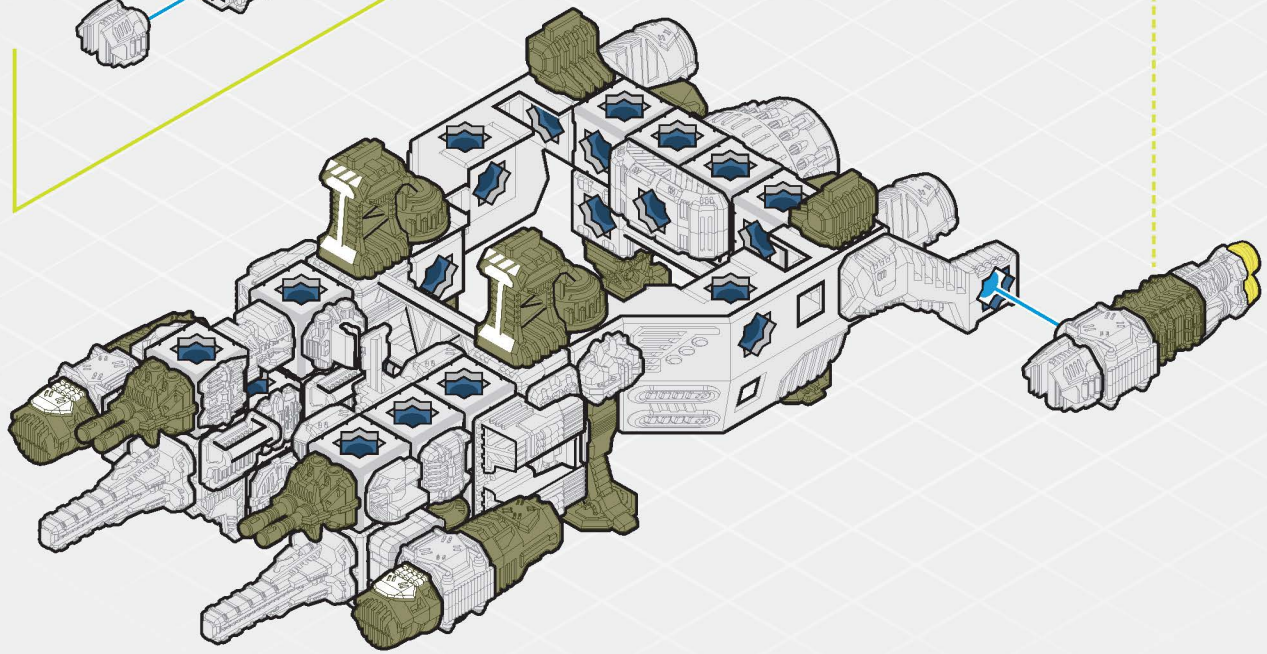
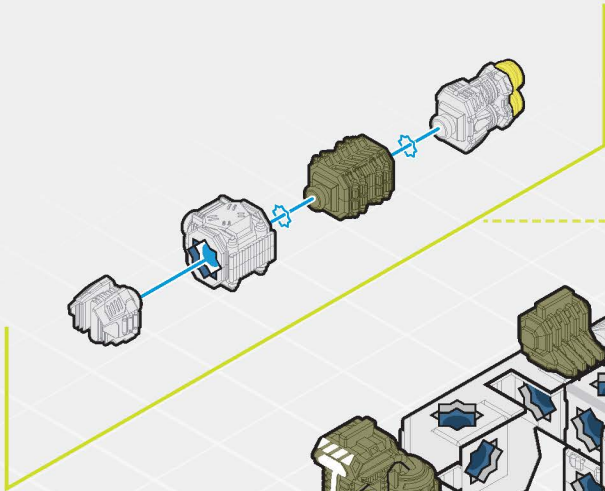
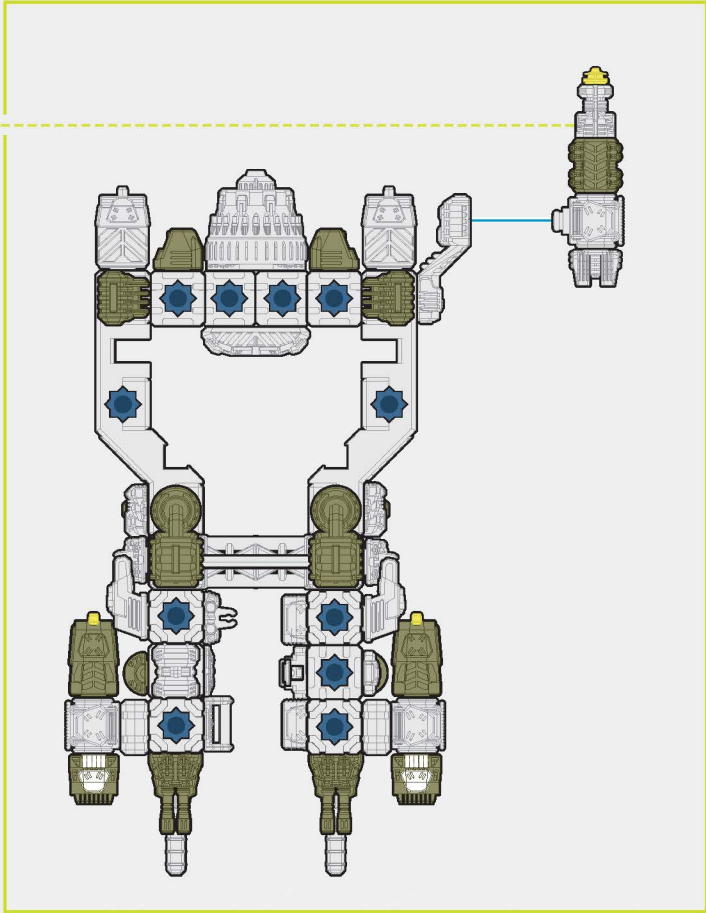
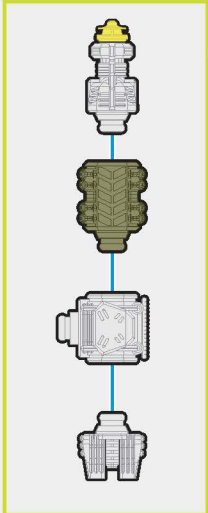





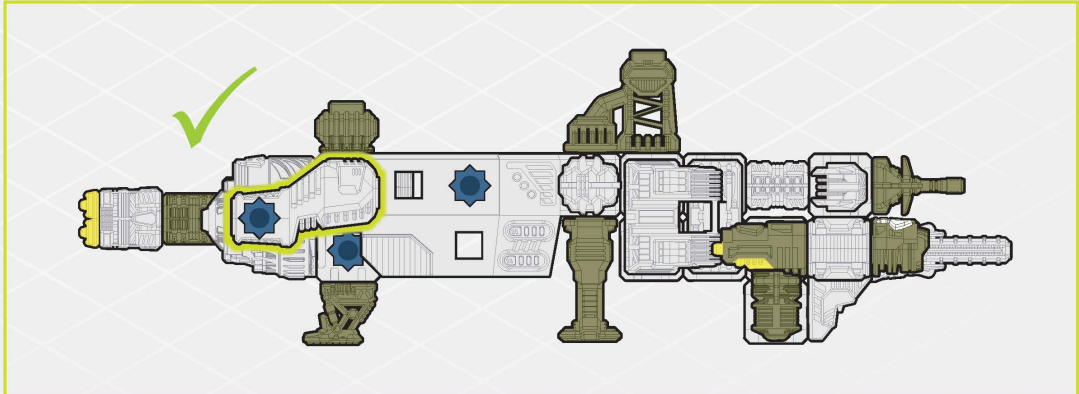
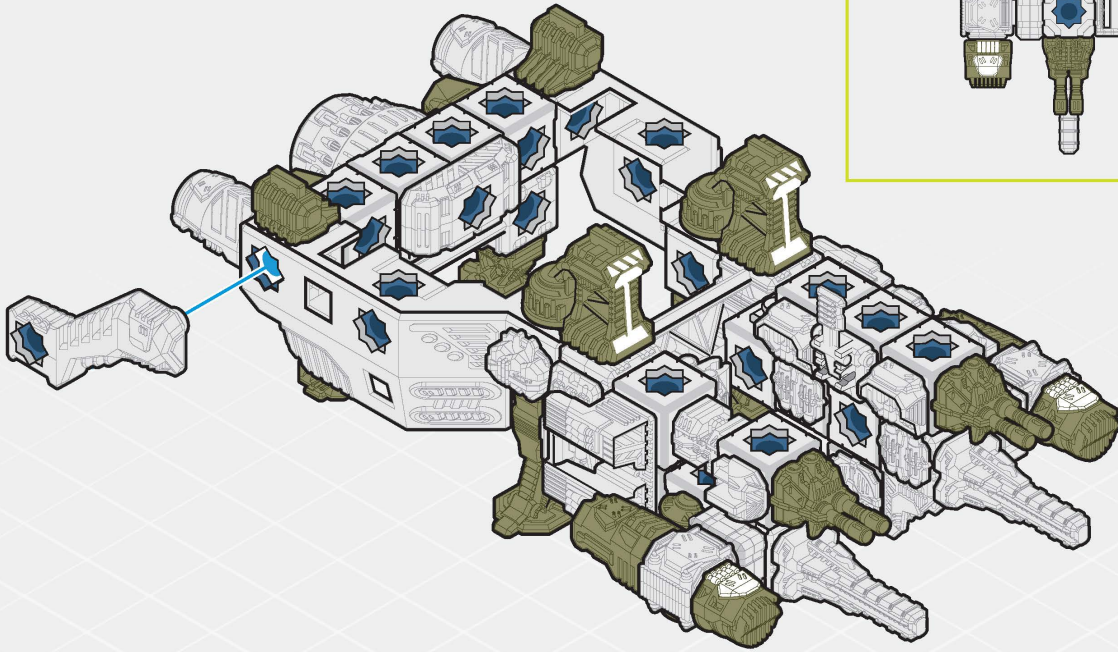
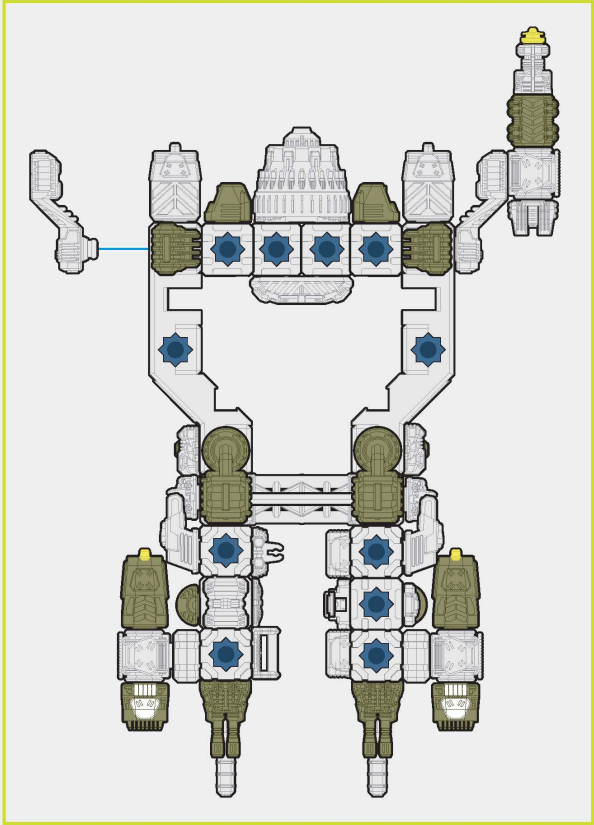
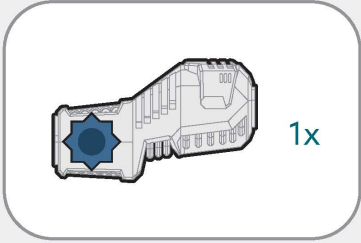

42



# 43

-  1x
-  1x
-  1x
-  1x

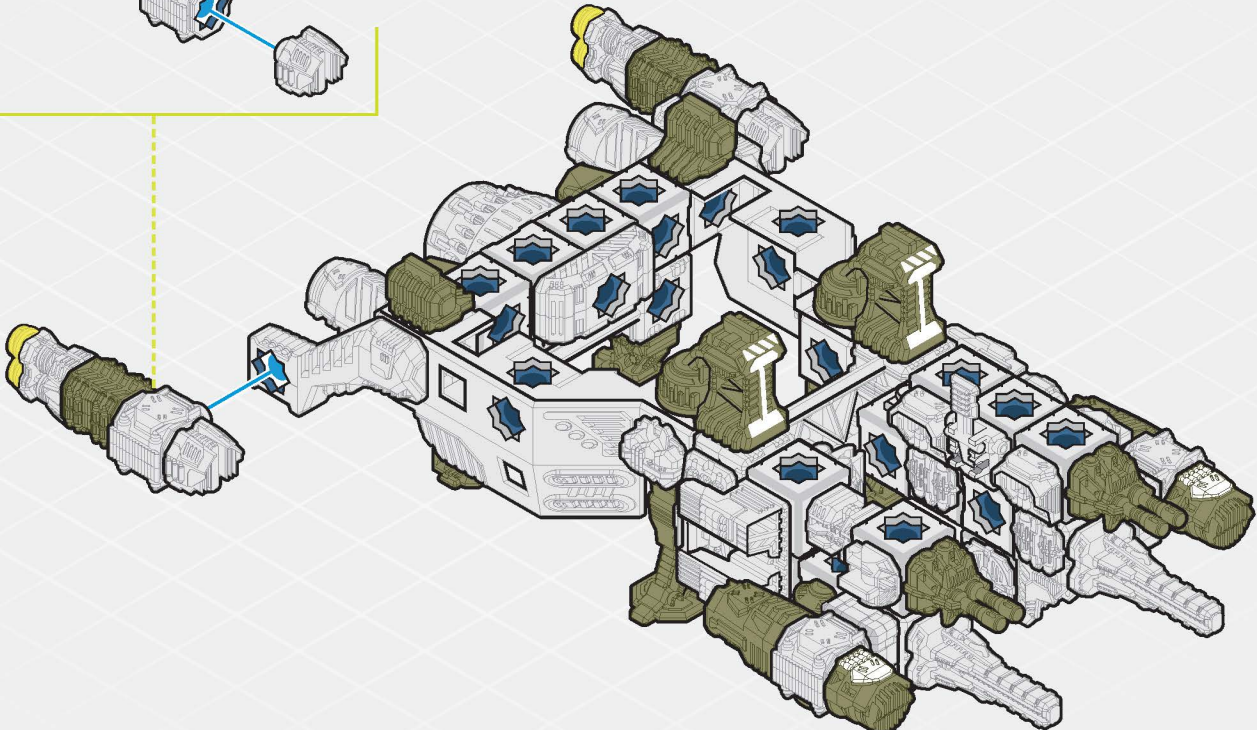
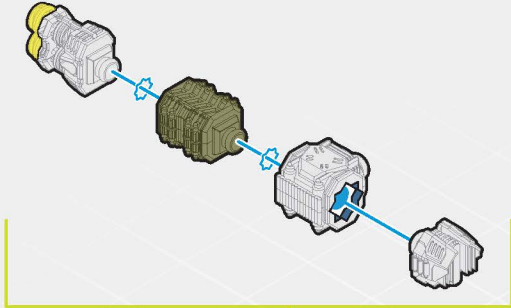
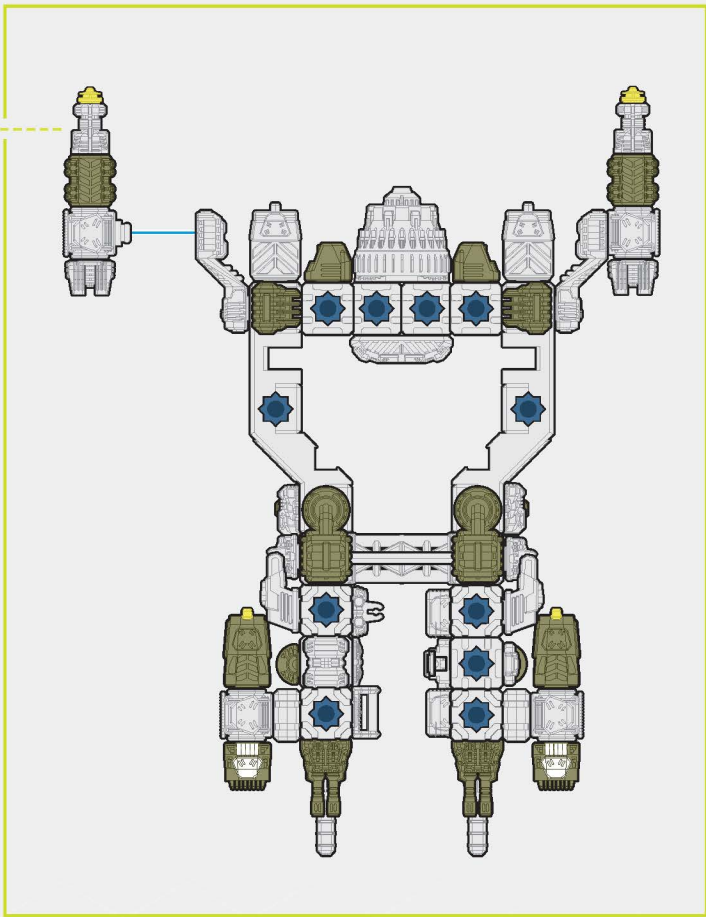
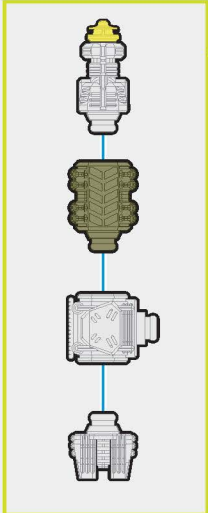



44

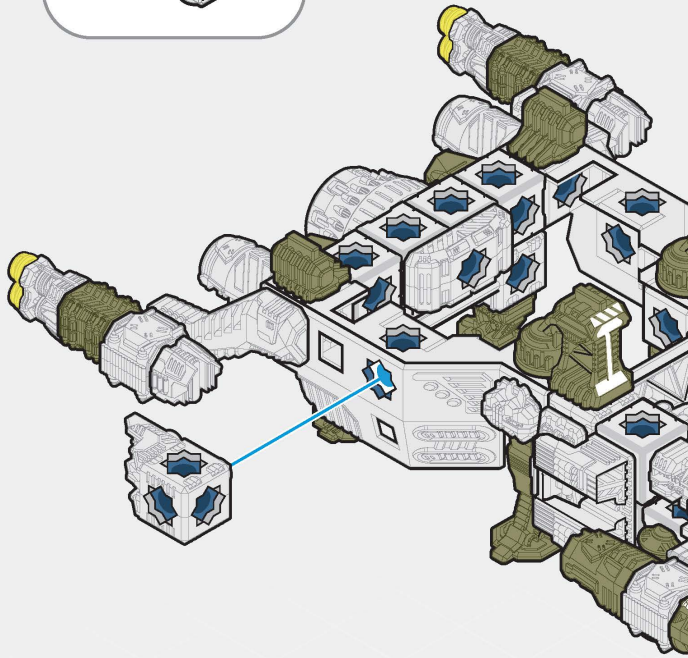
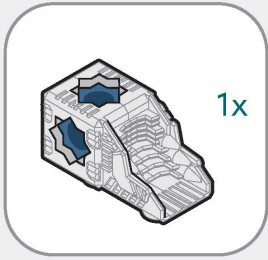

45

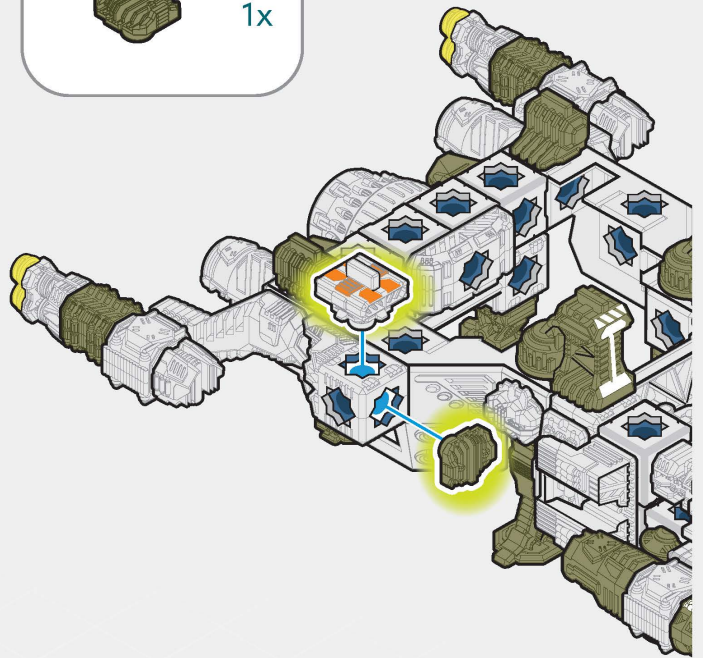
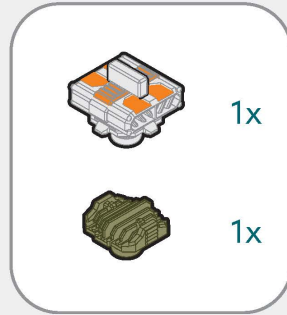

CLAYMORE CR-76 COMBAT TRANSPORT

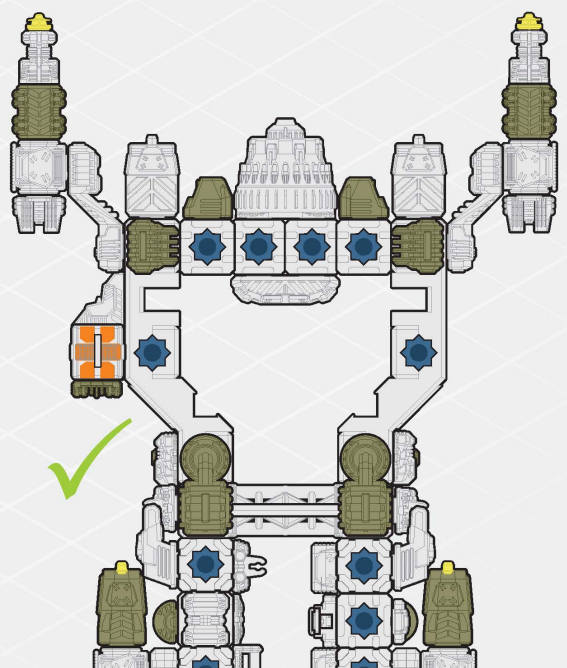
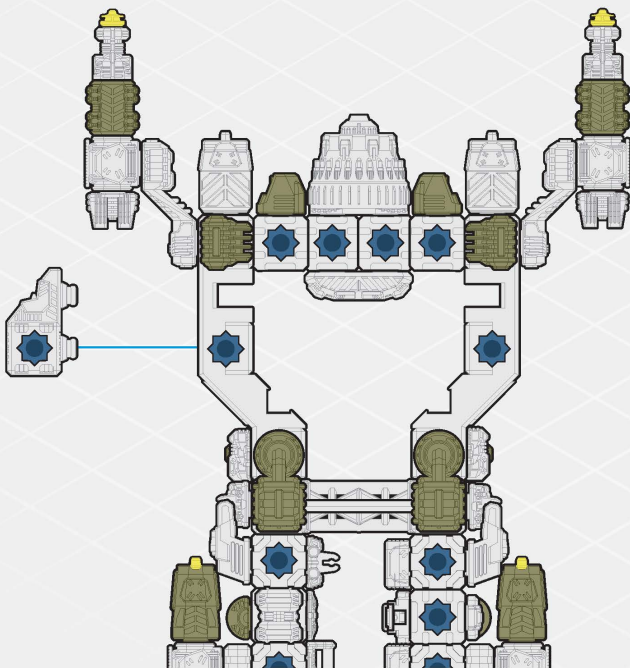

# 46

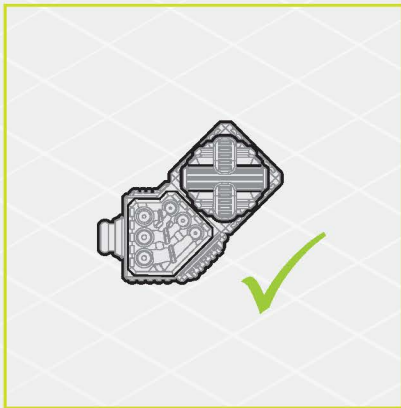
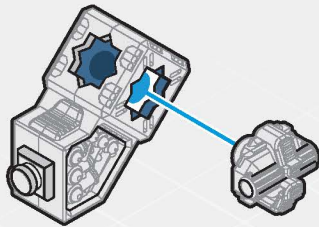

# 47

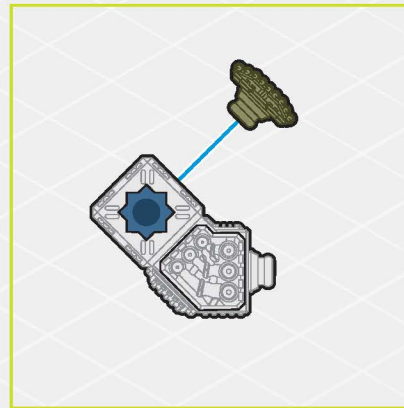
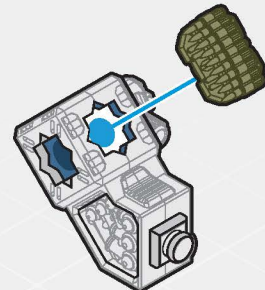
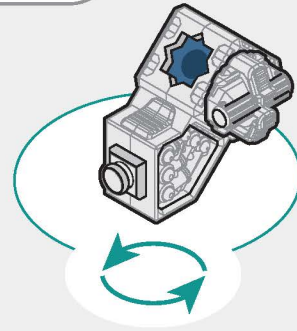



48

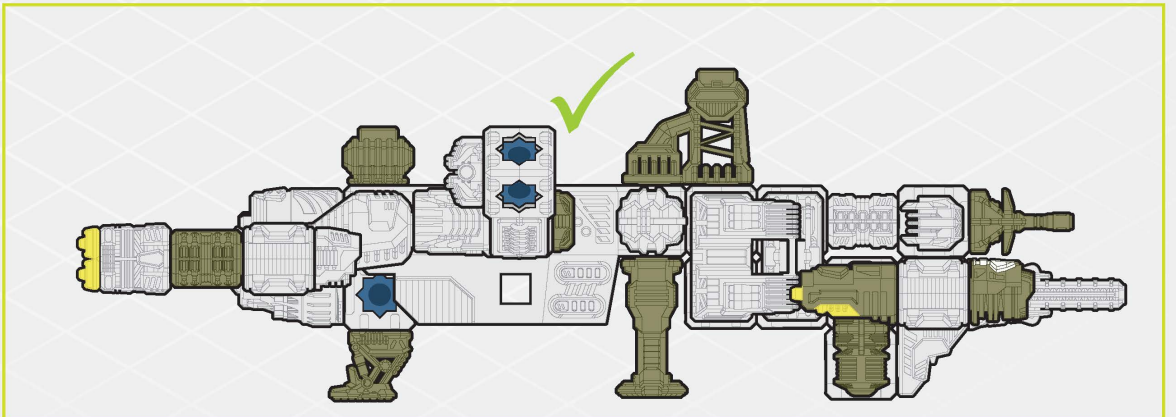
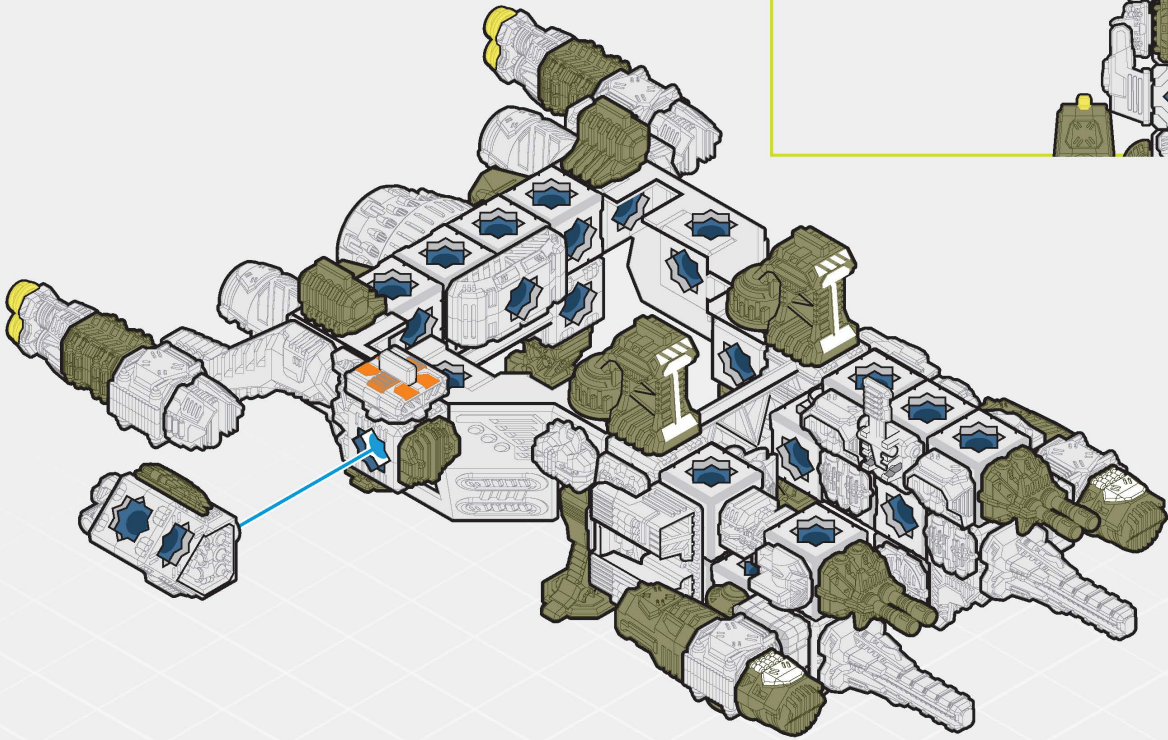
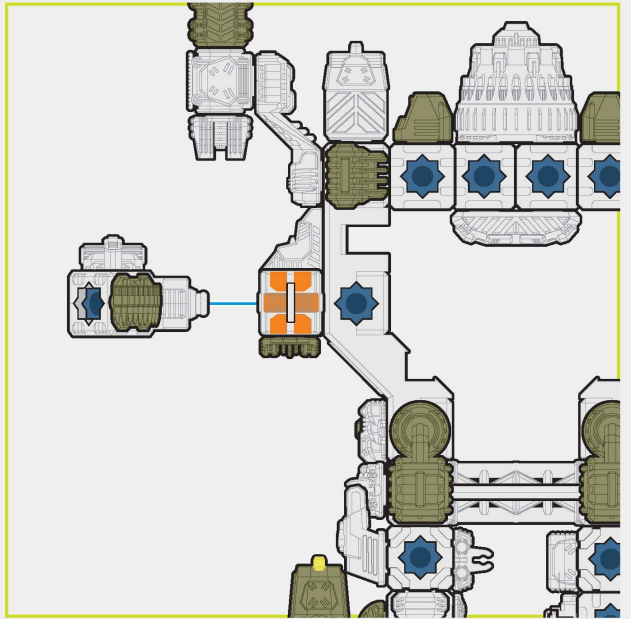

# 49

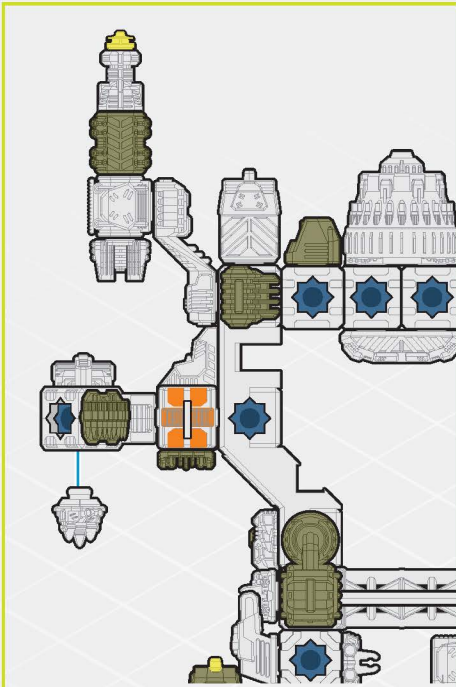
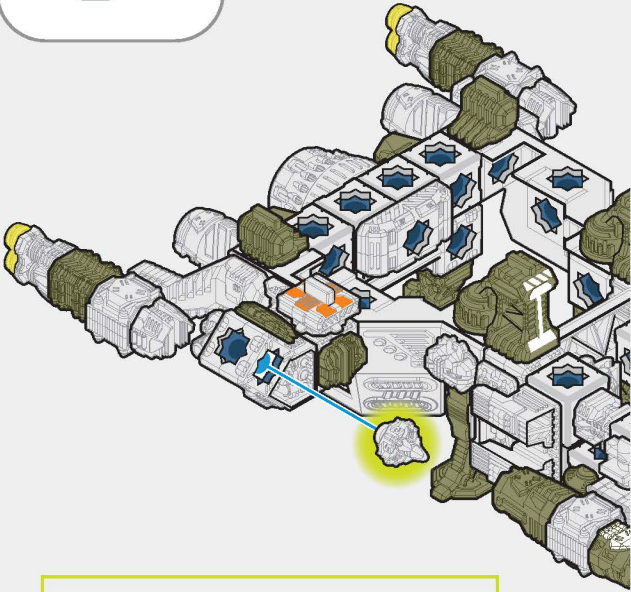

# 50

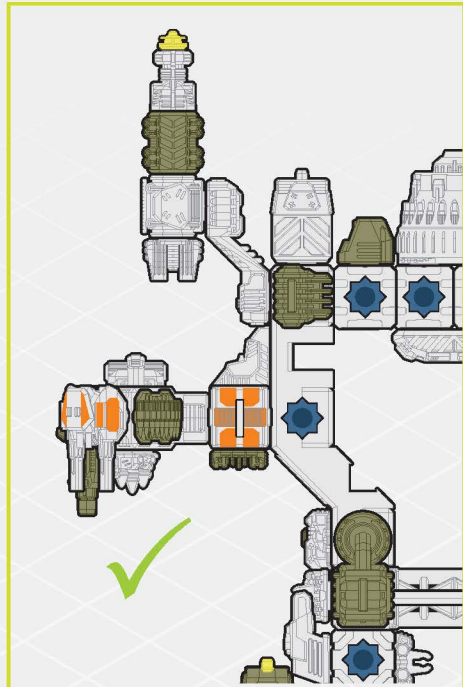
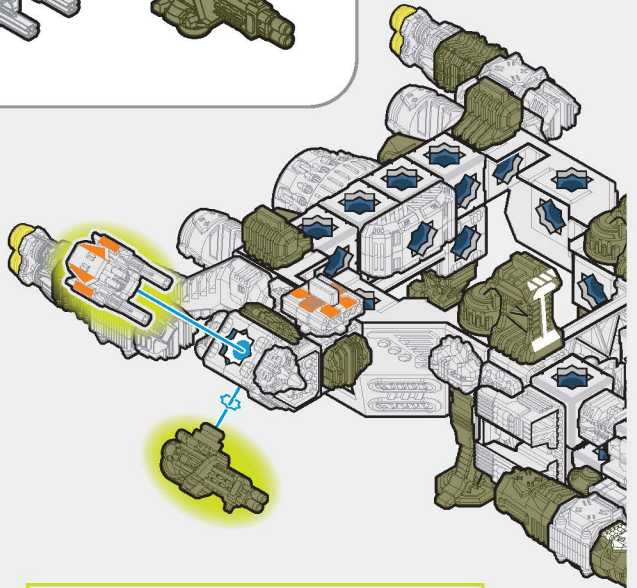
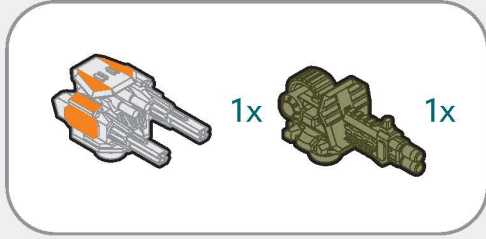



51

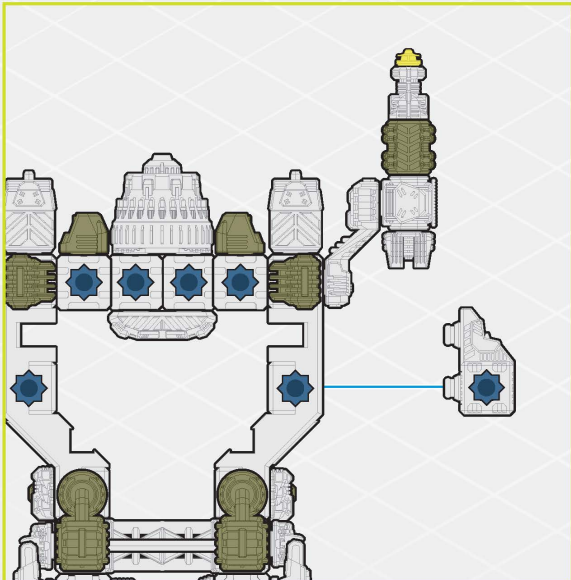
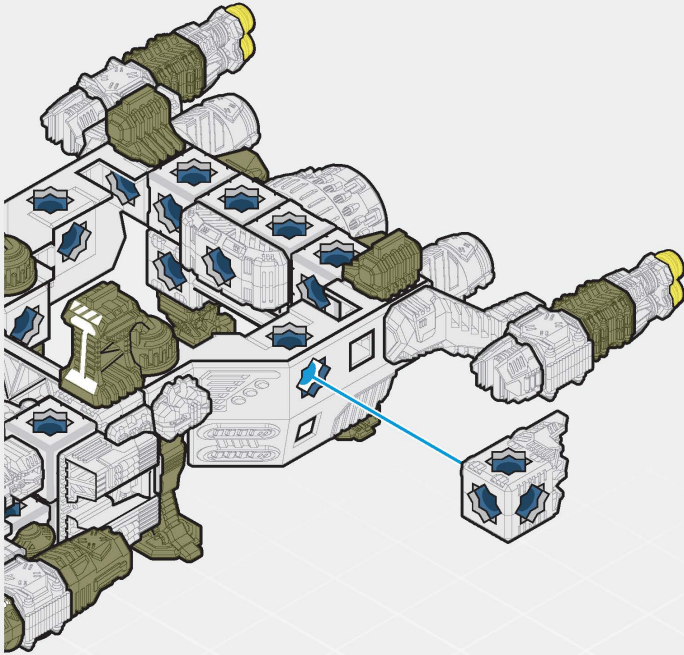

52

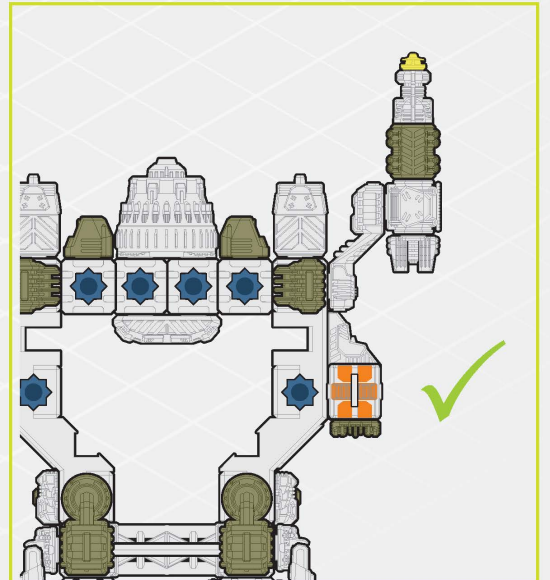
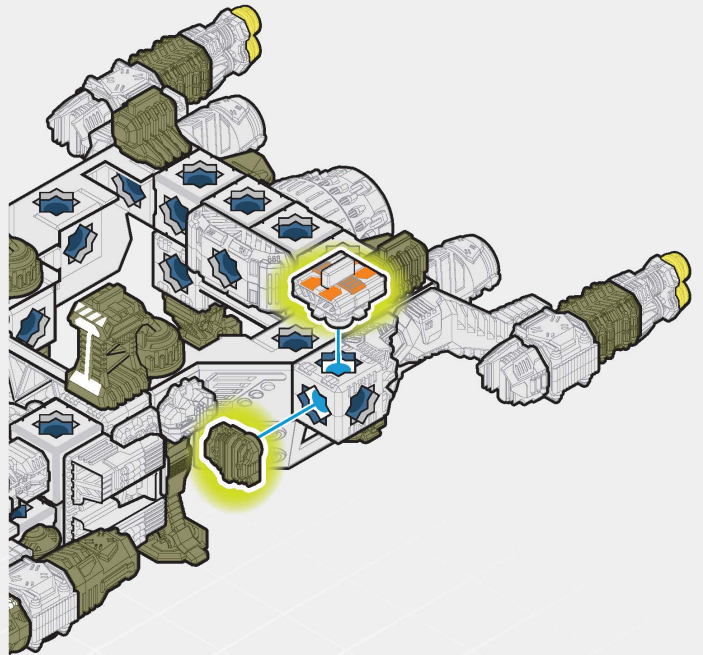

# 53

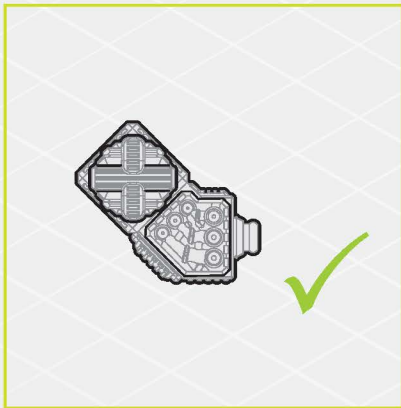
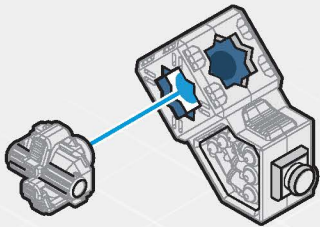
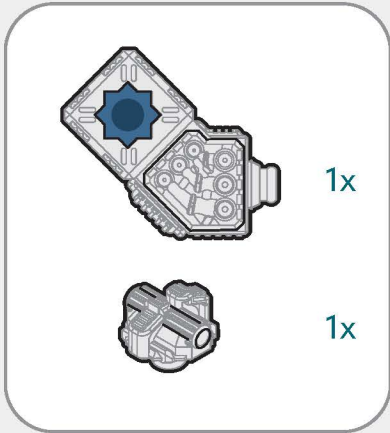

# 54

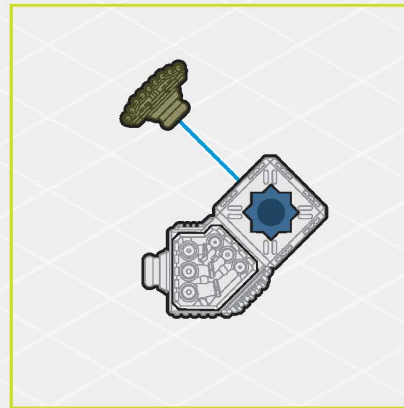
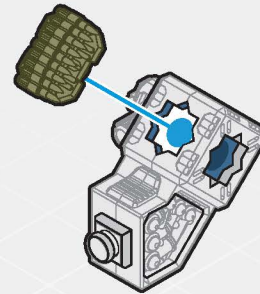
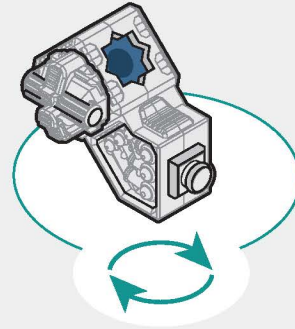



55

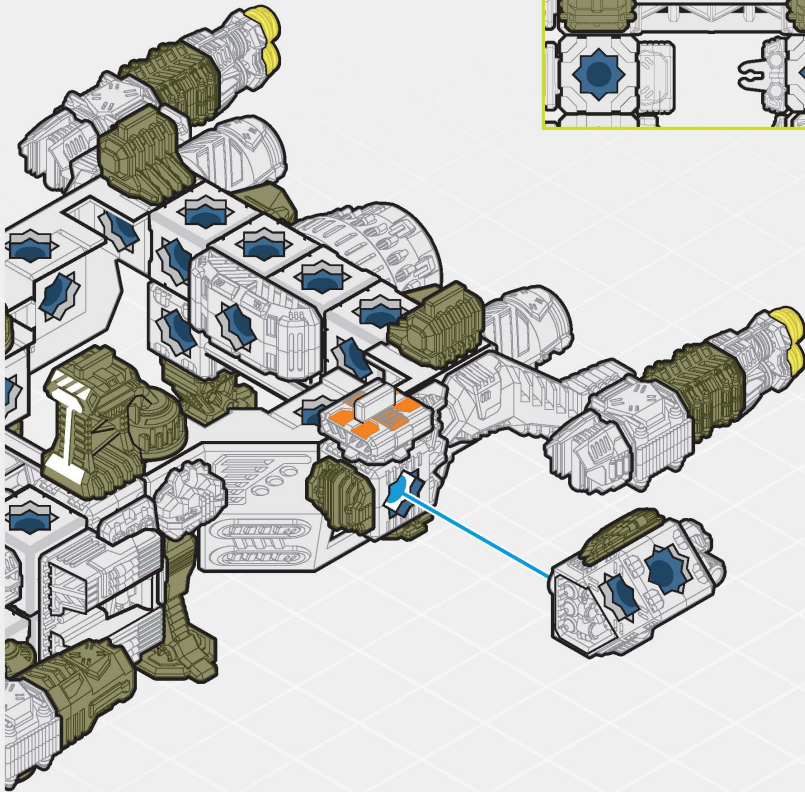
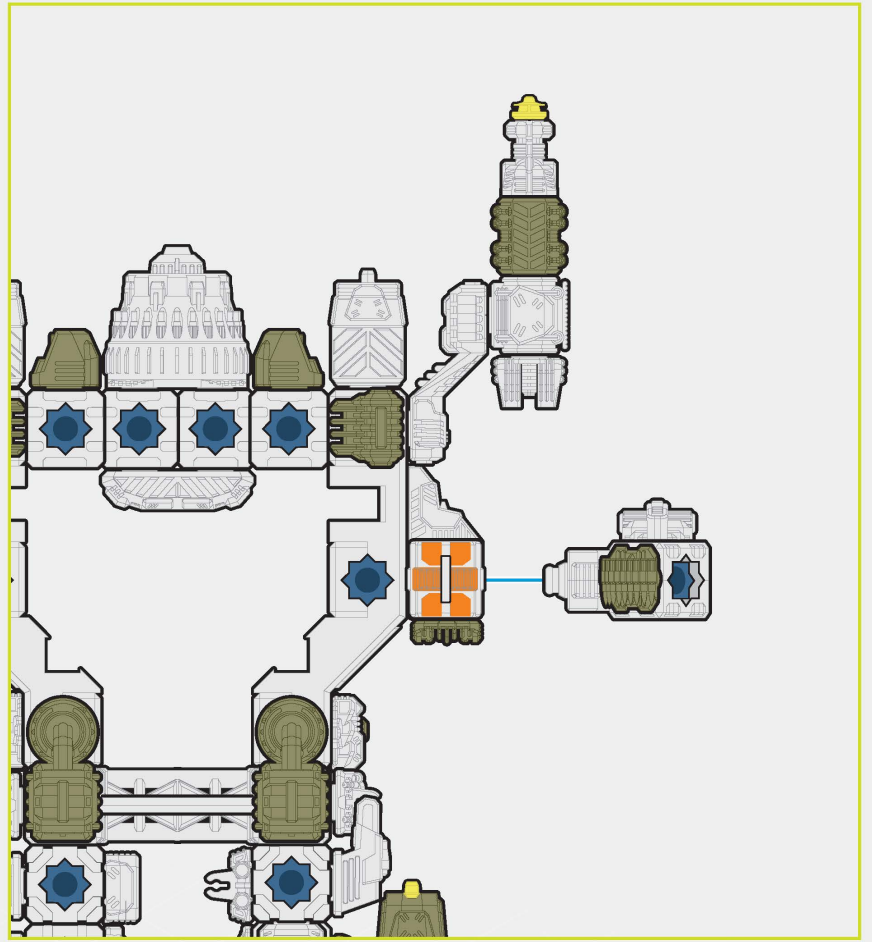

# 56

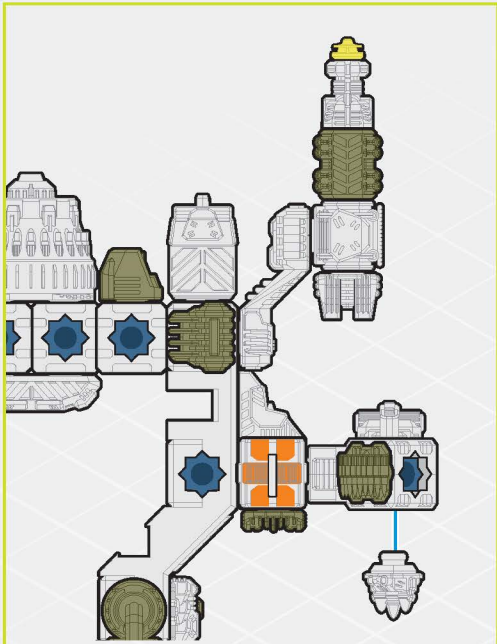
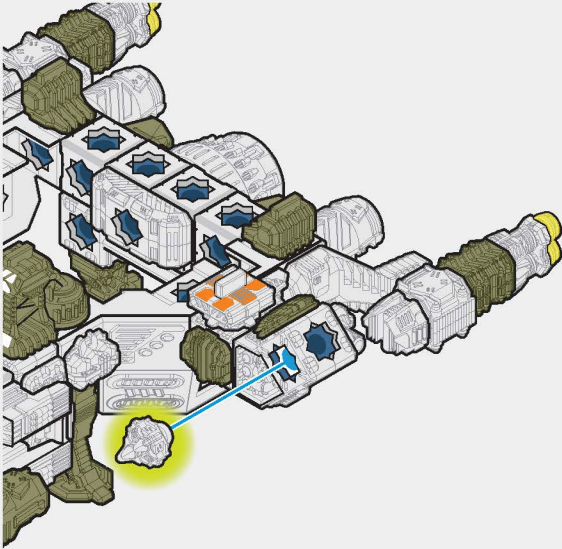

# 57

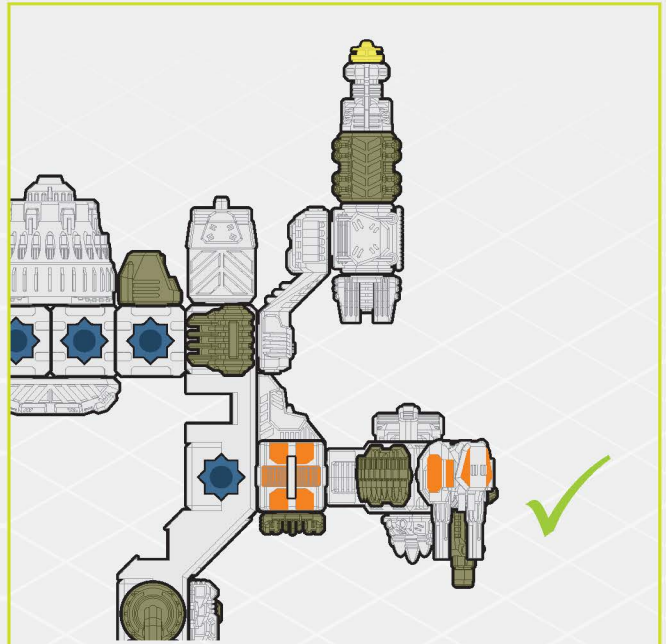
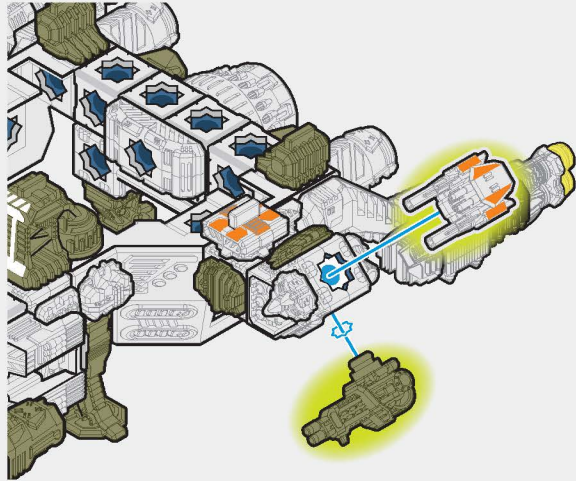
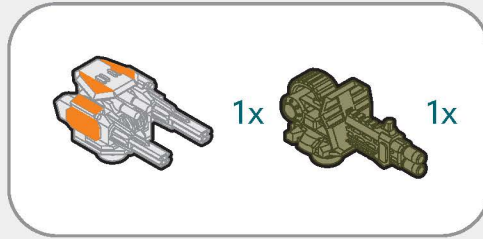



# 58

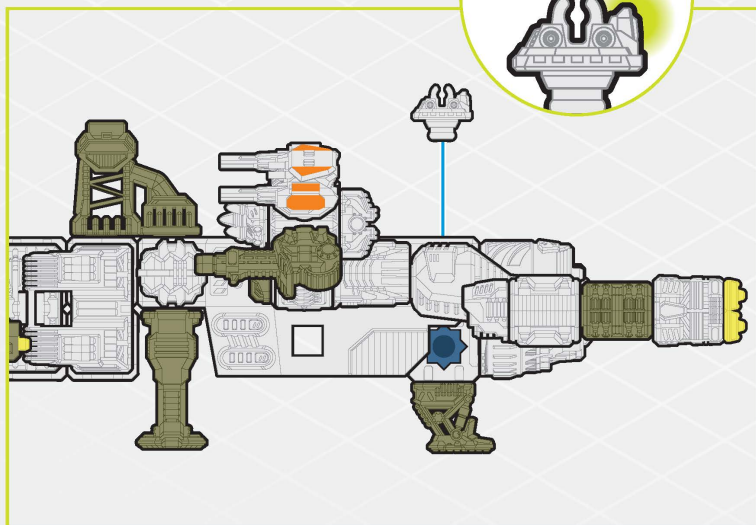
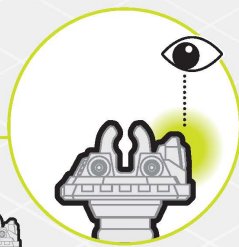
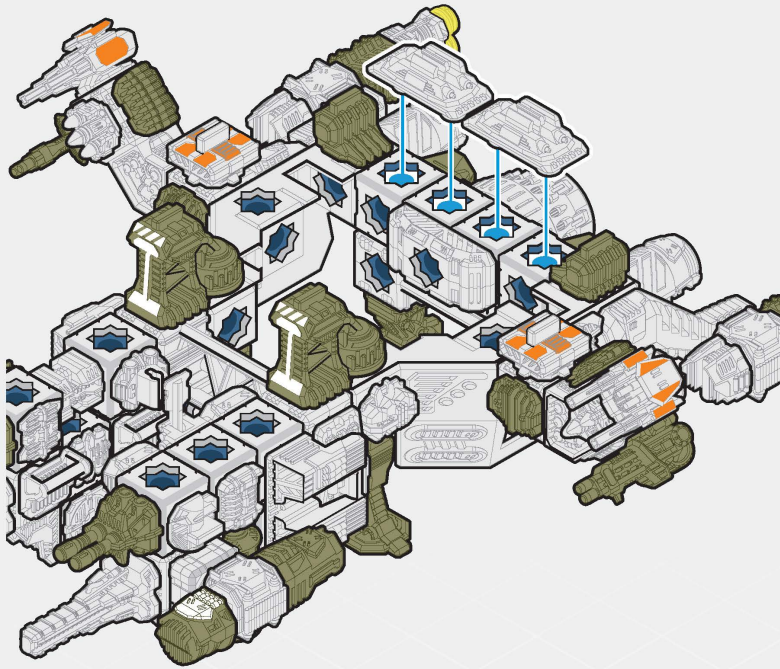
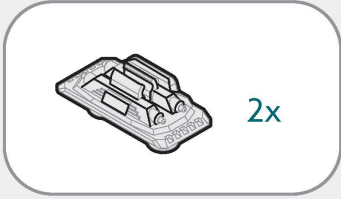

# 59

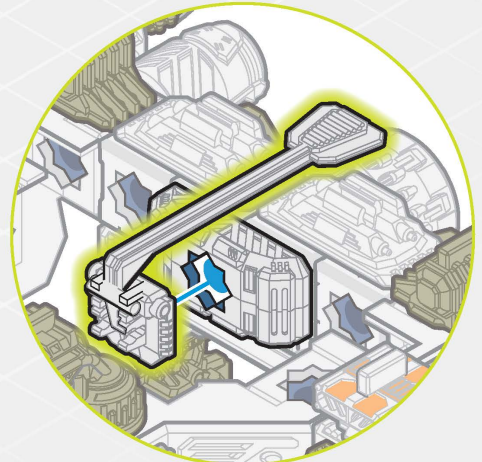
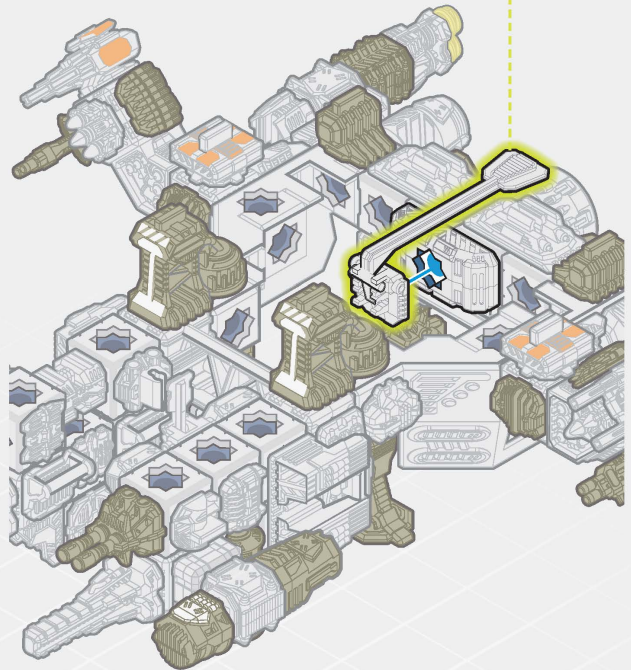
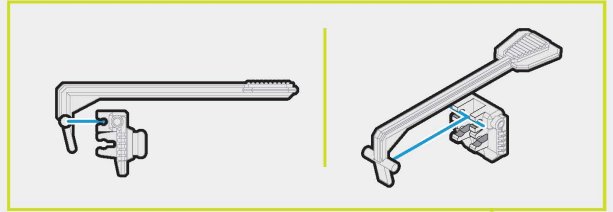
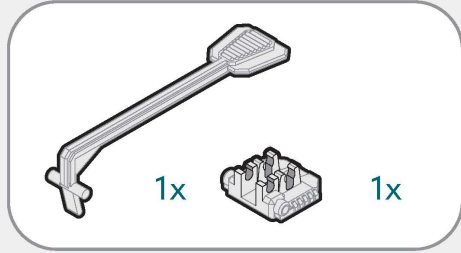

# 60

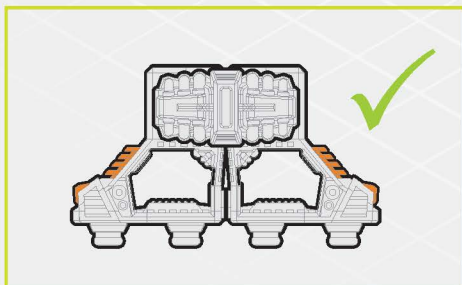
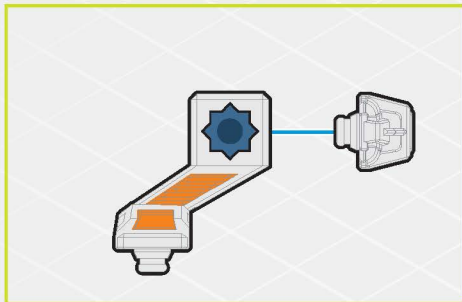
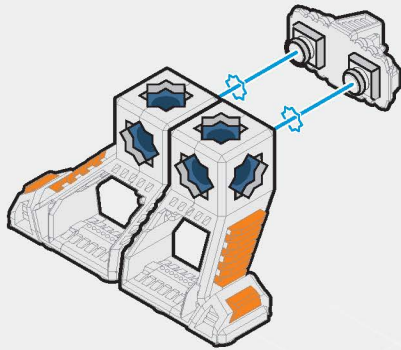
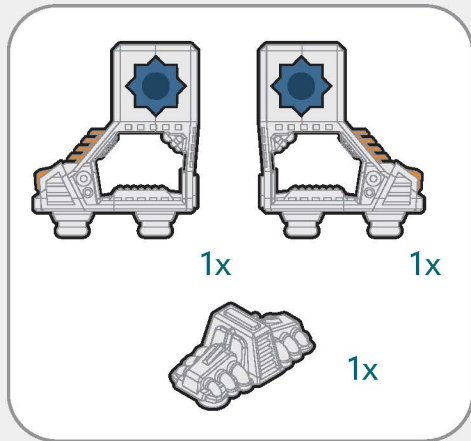

# 61

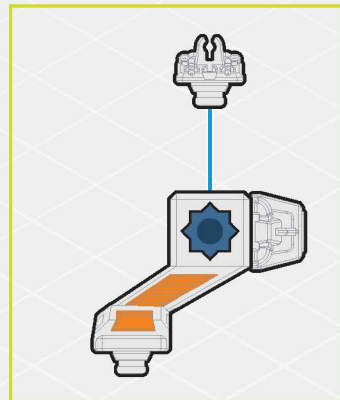
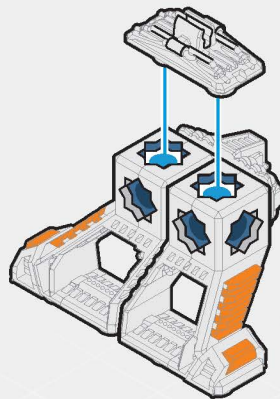
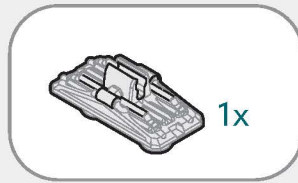

# 62

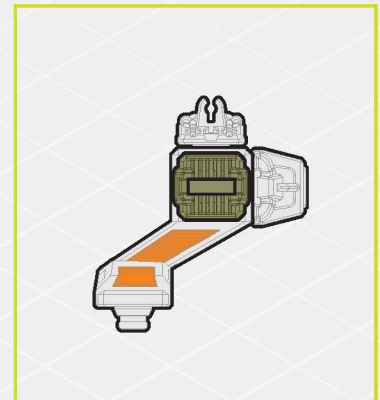
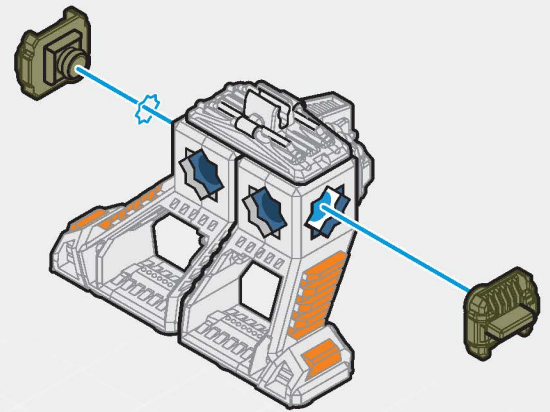



63

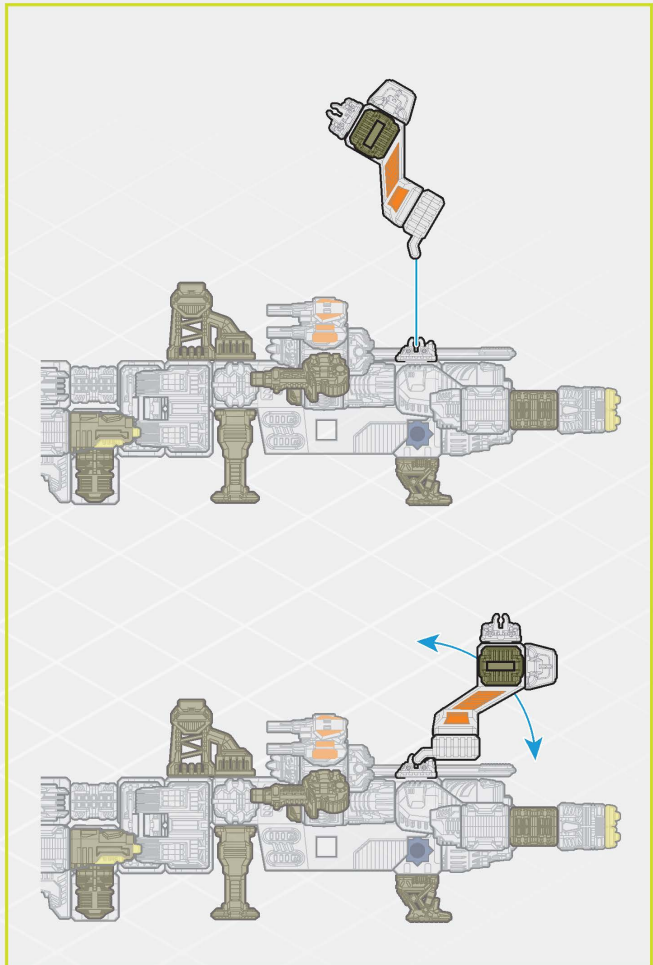
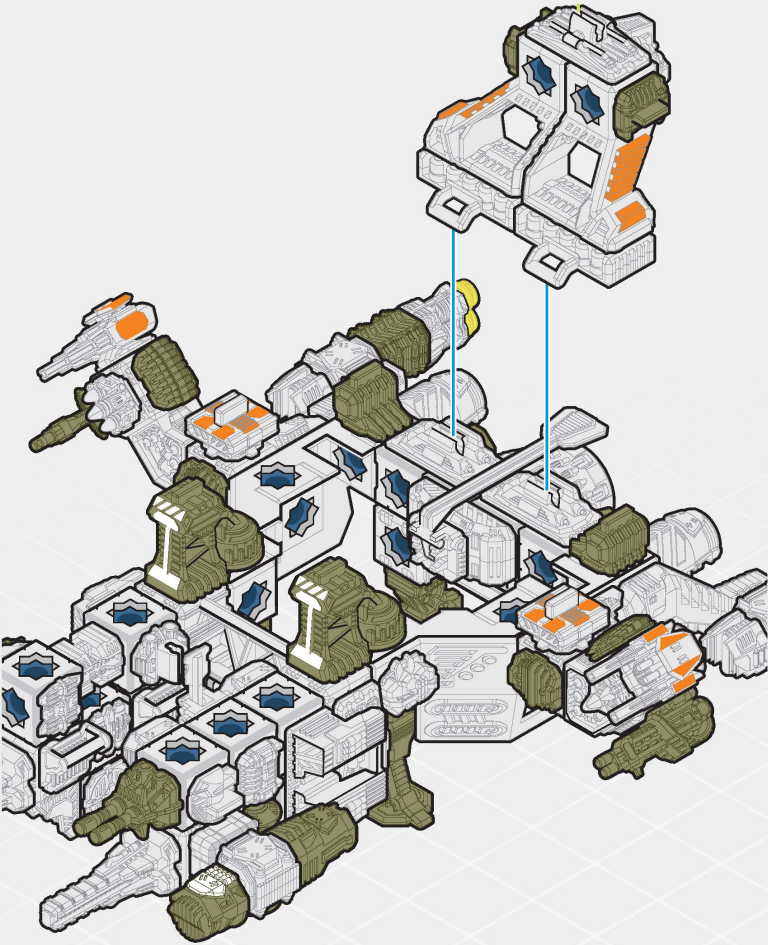
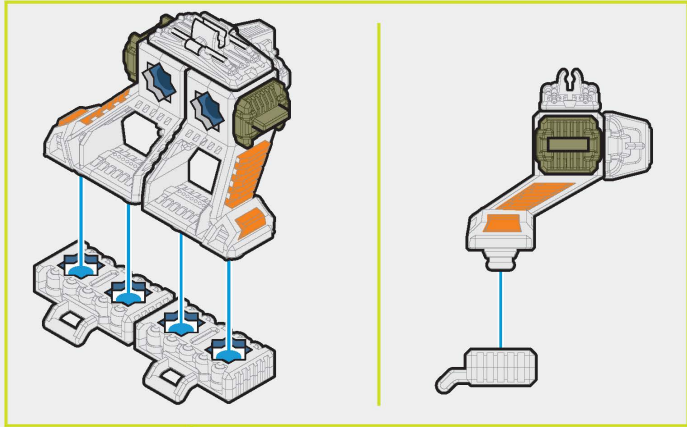
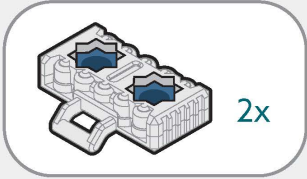

# 64

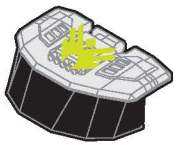

1x

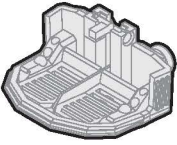

1x



1x



1x

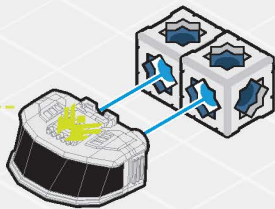
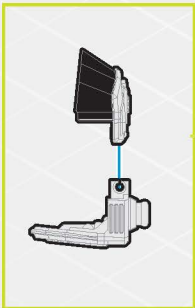
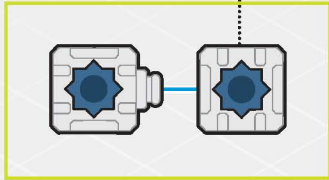

# 65

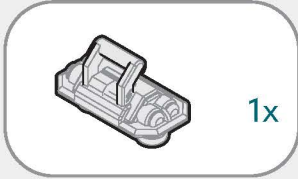

1x

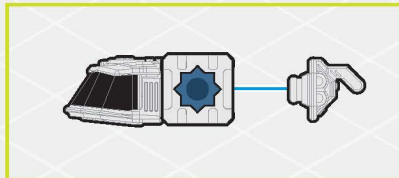
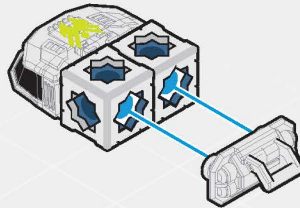

# 66

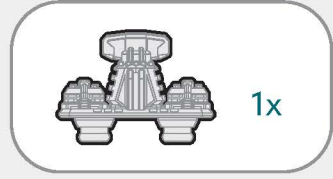

1x

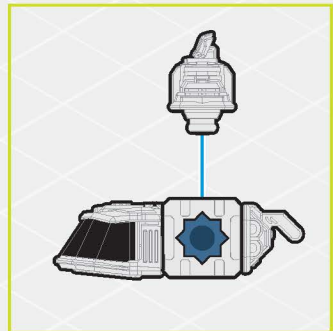
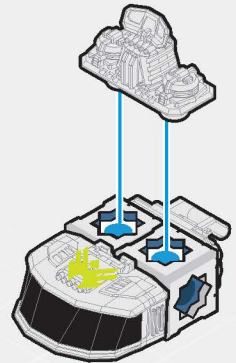



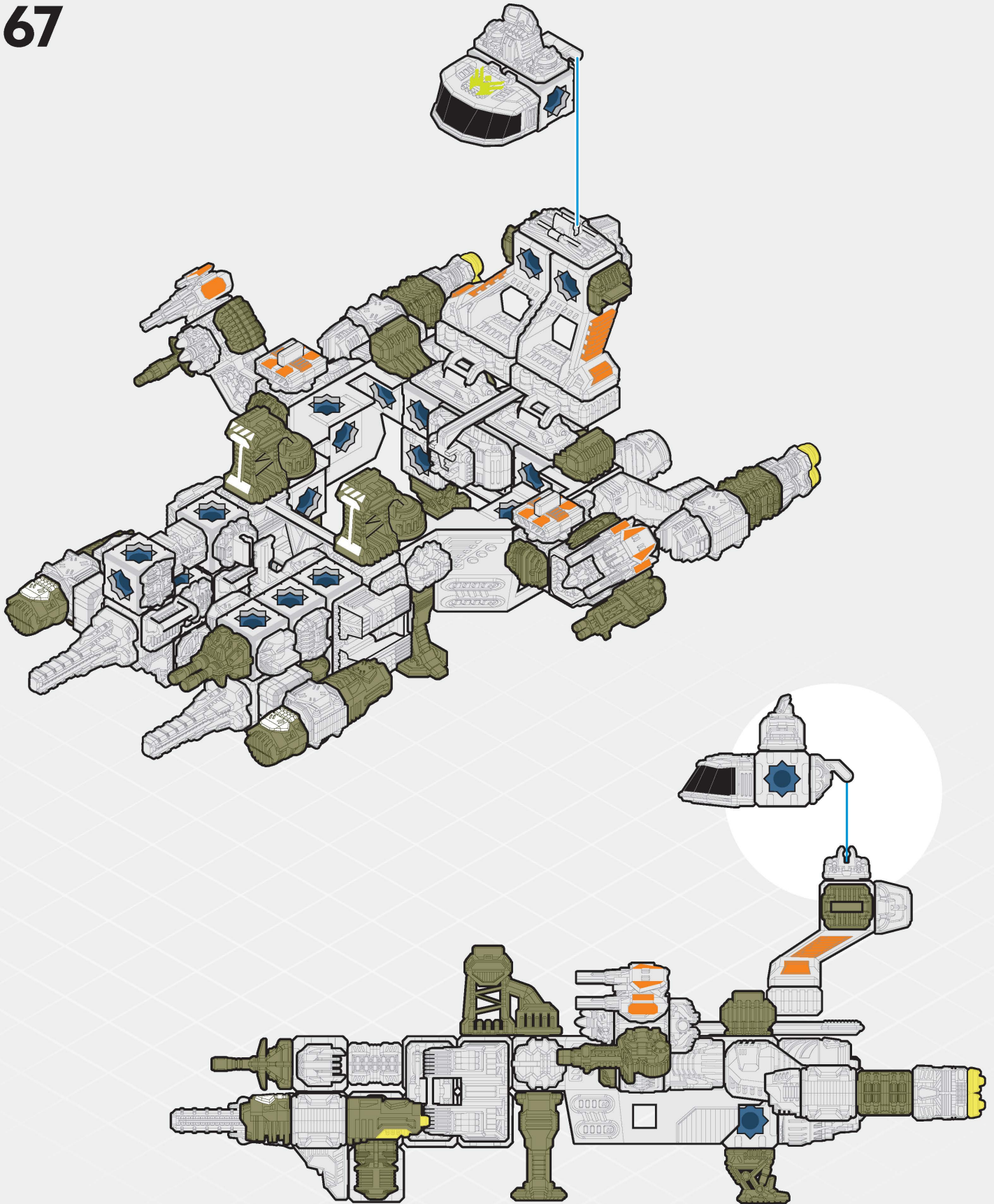

68



2x

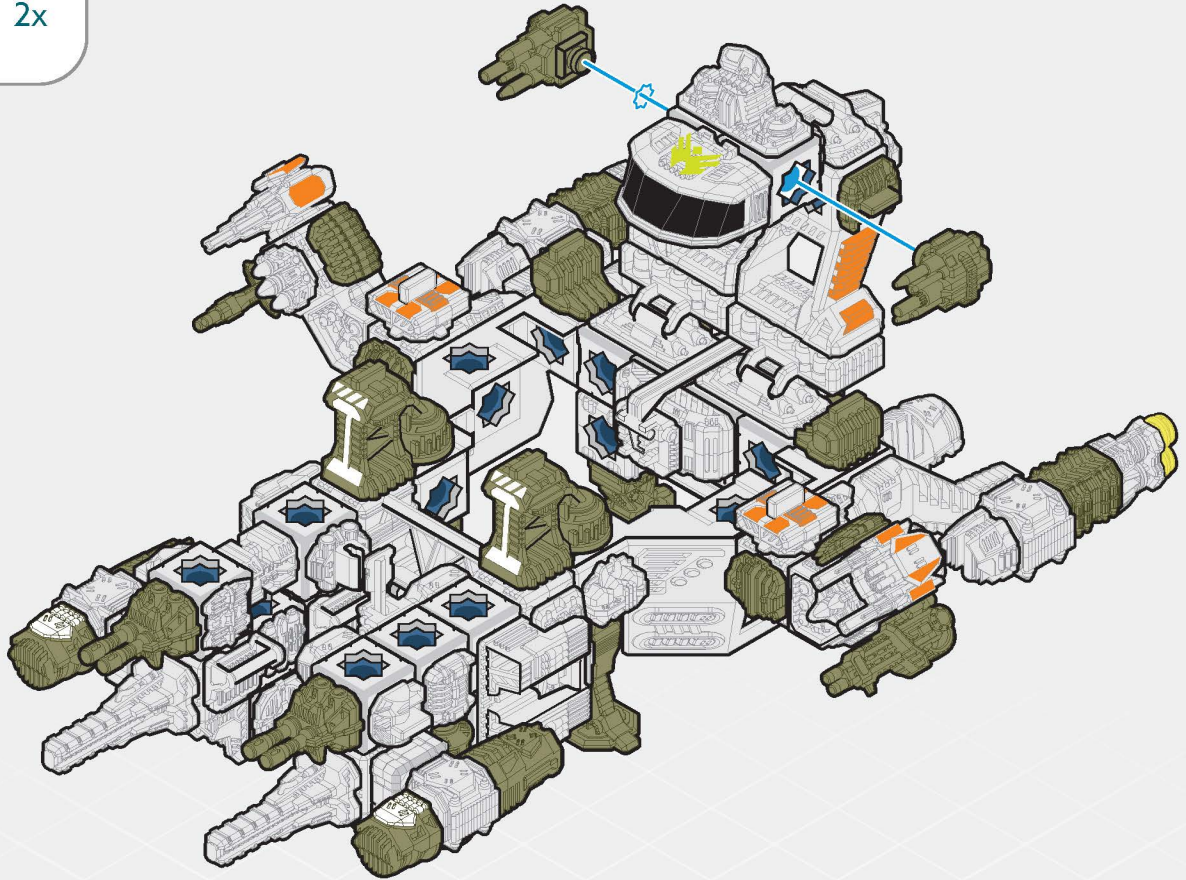





=

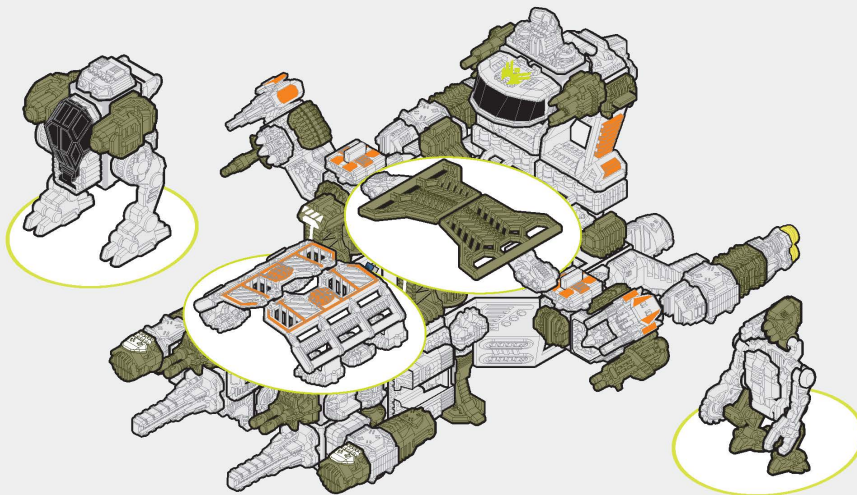

69

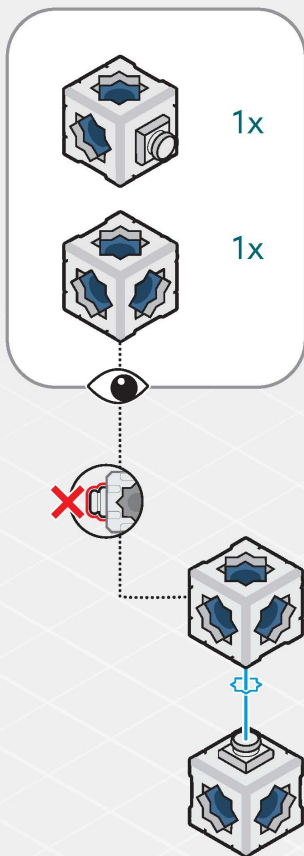

70

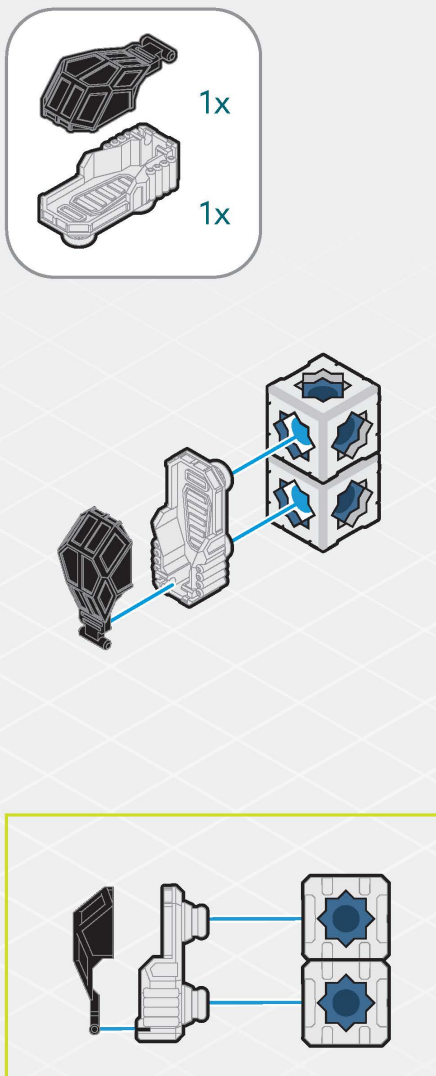

71



# 72

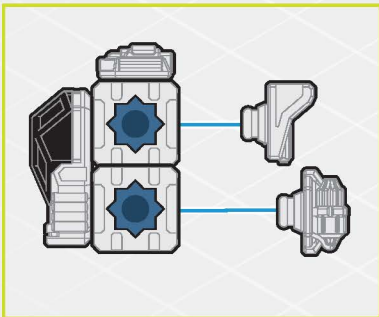
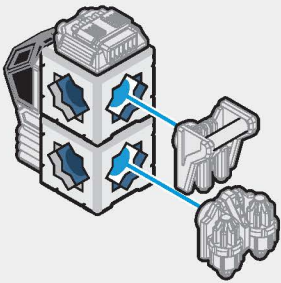

# 73

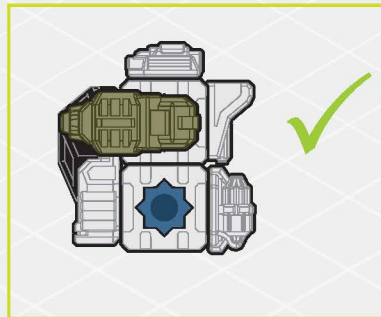
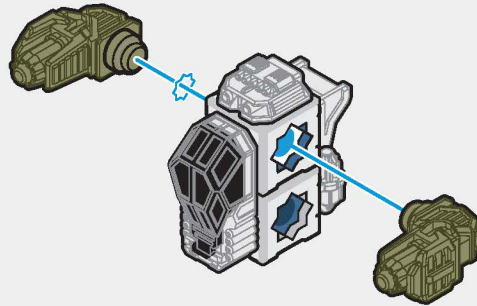

# 74

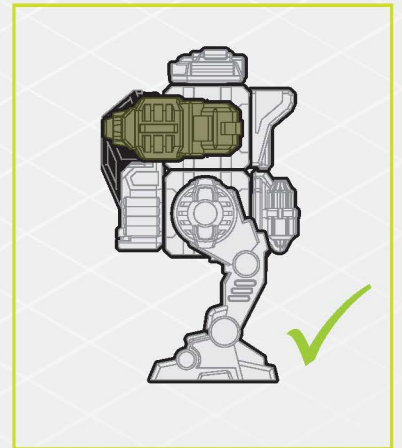
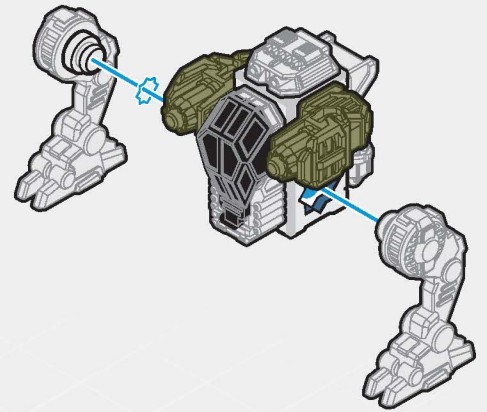
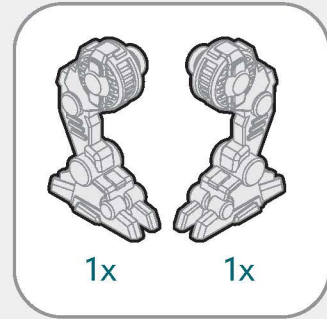



75

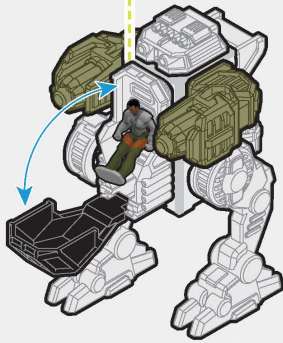

76

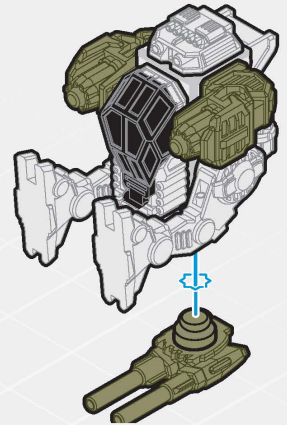
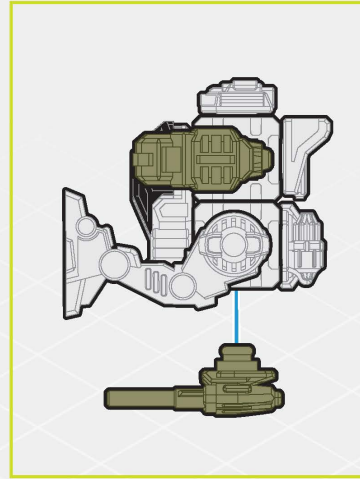
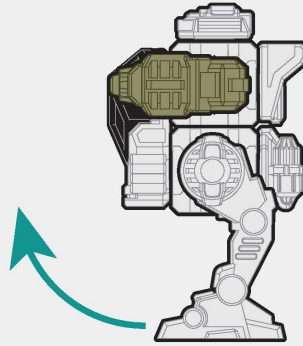

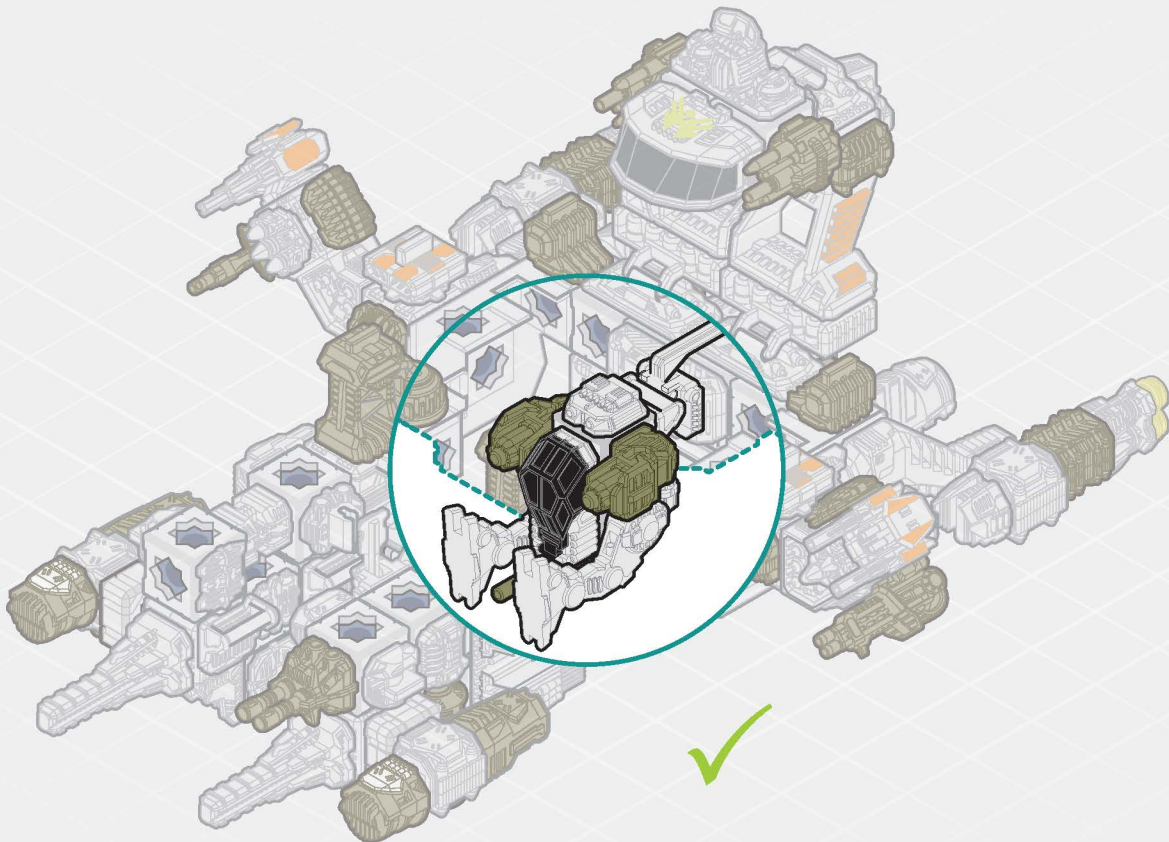
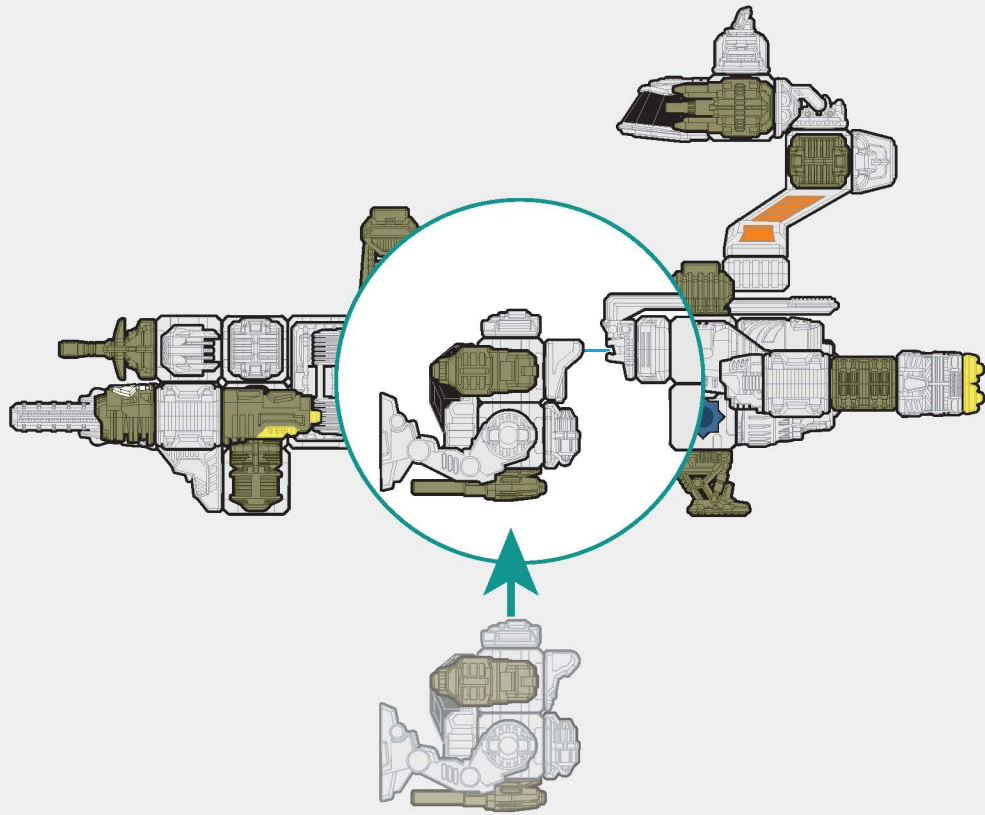



# 78

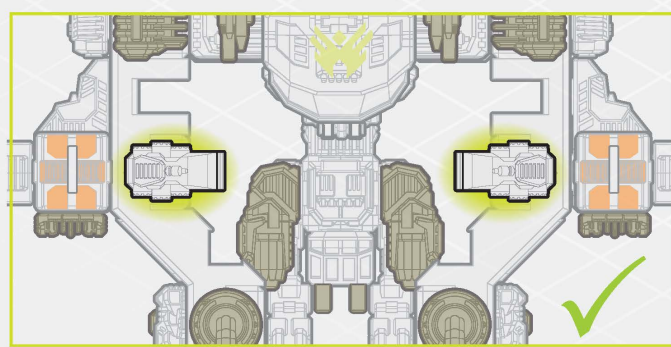
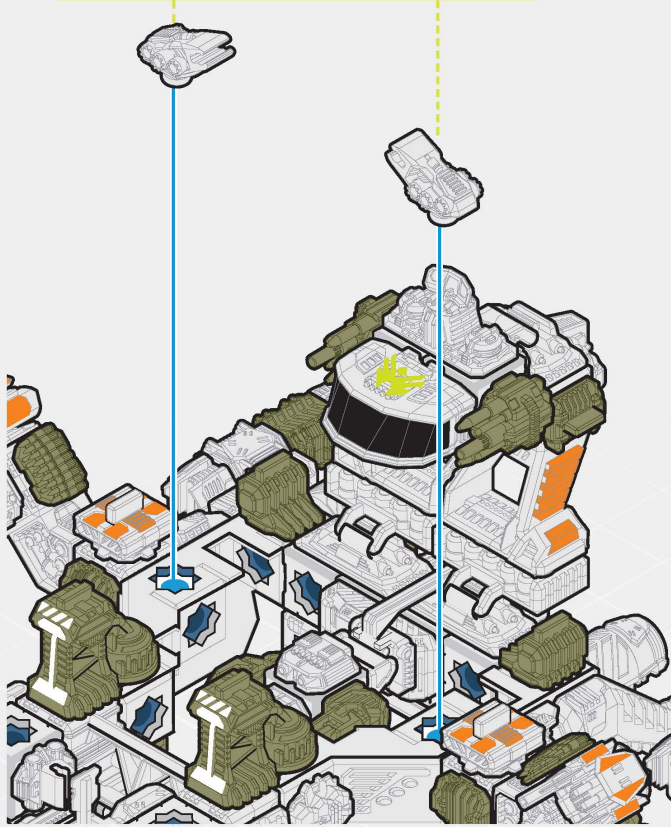
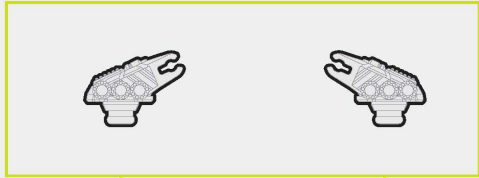
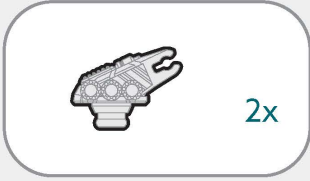

# 79

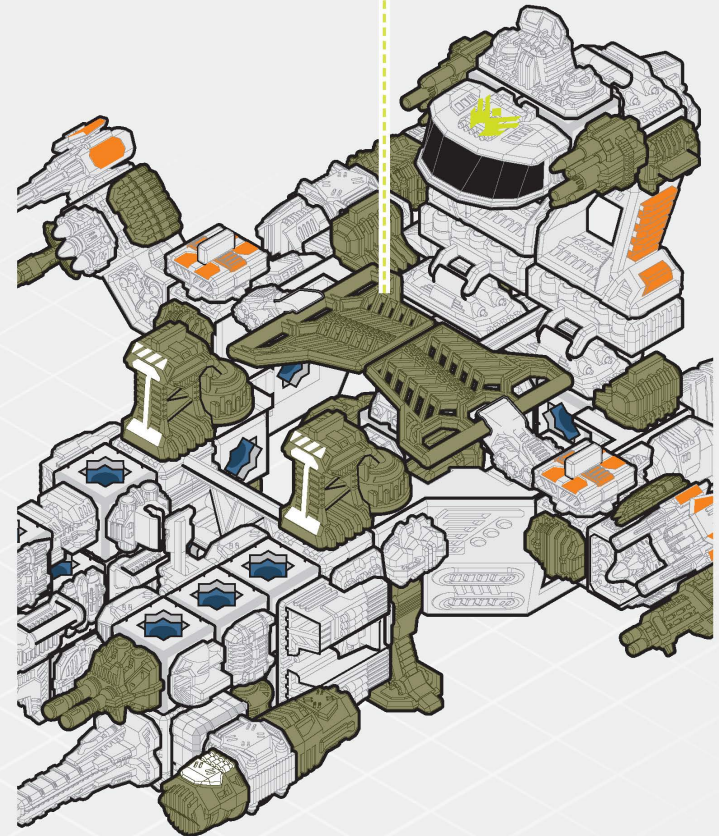
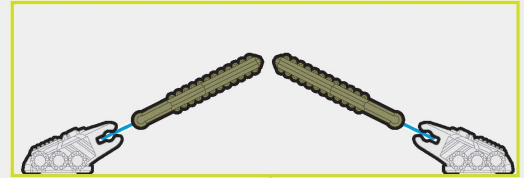
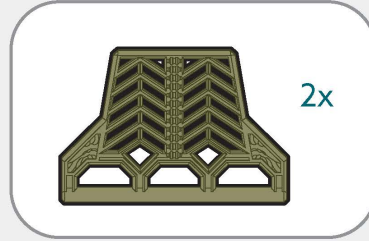

CLAYMORE CR-76 COMBAT TRANSPORT

80

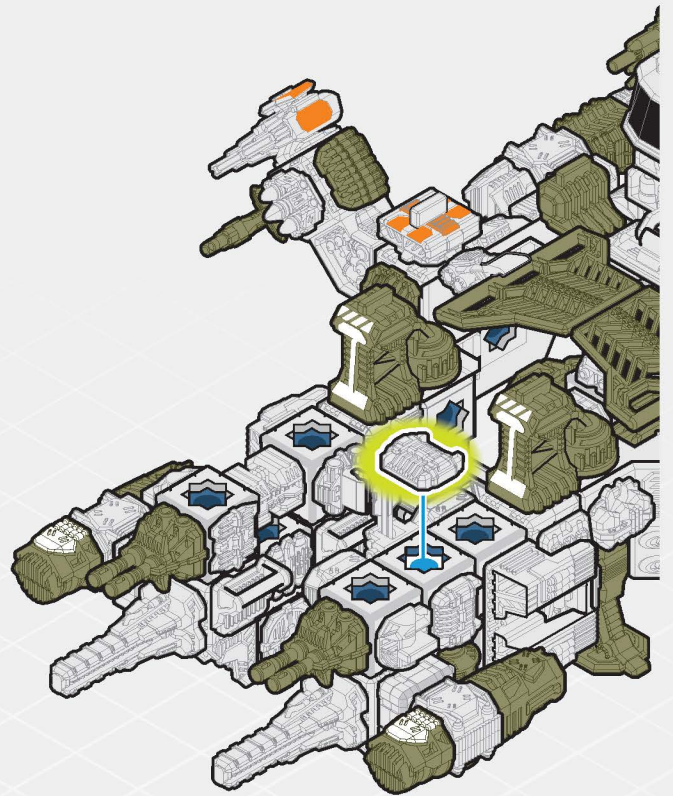
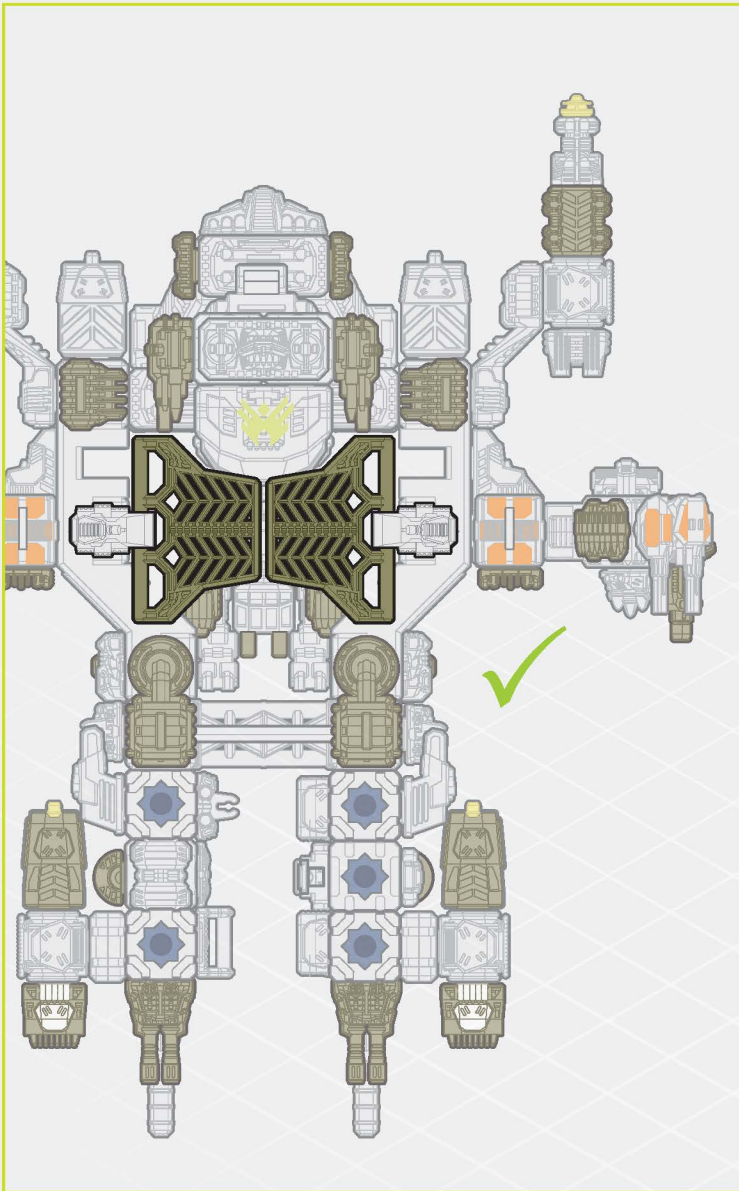



81

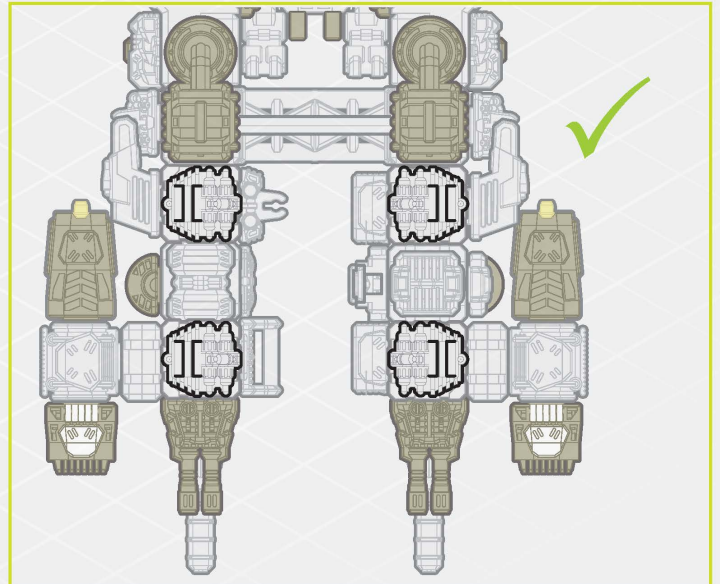
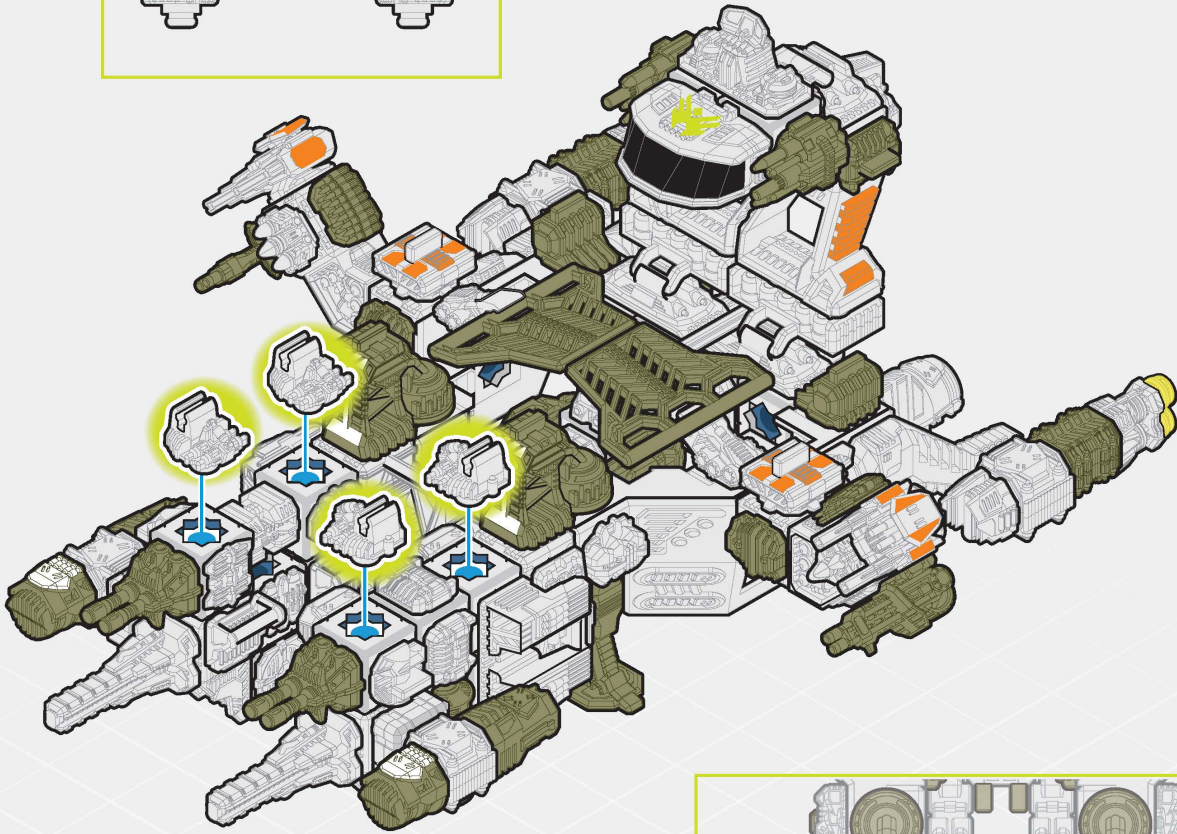
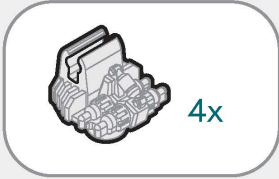



82

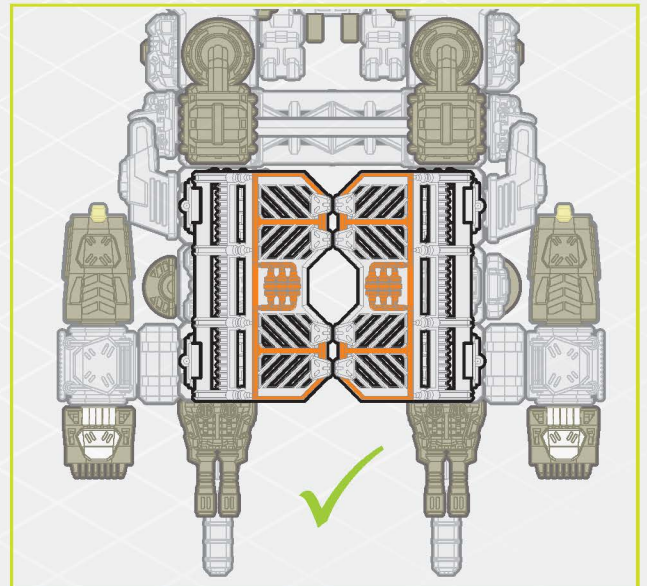
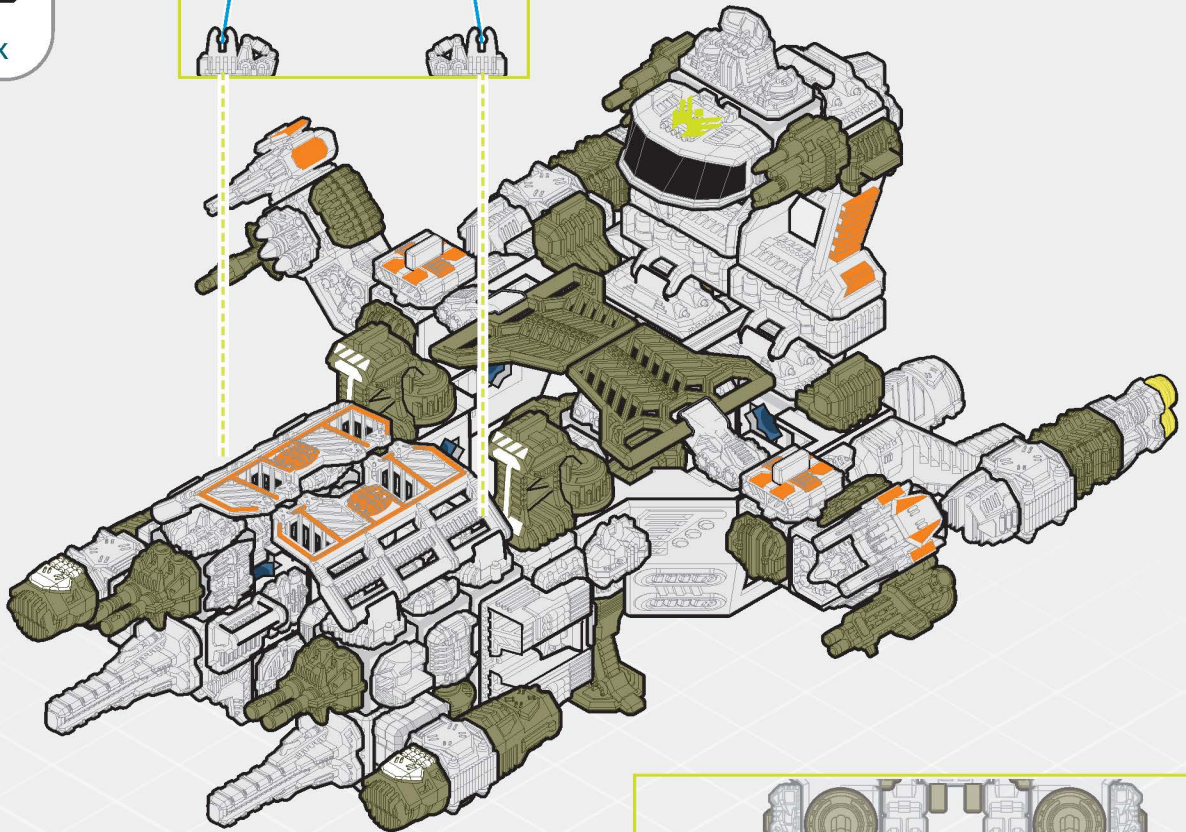
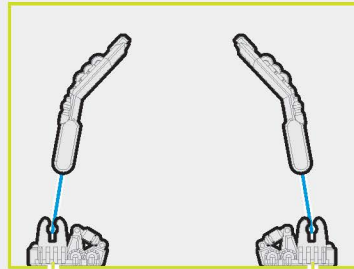
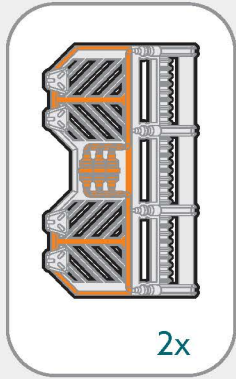

83

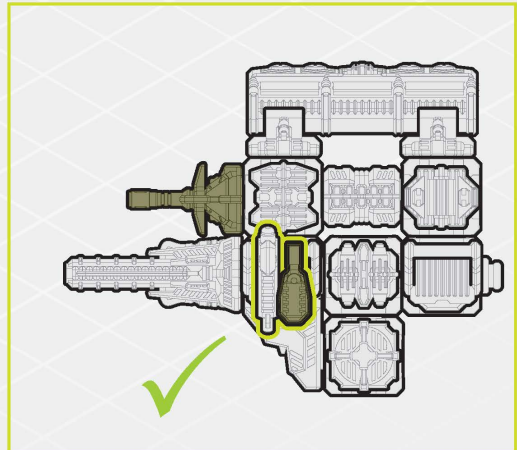
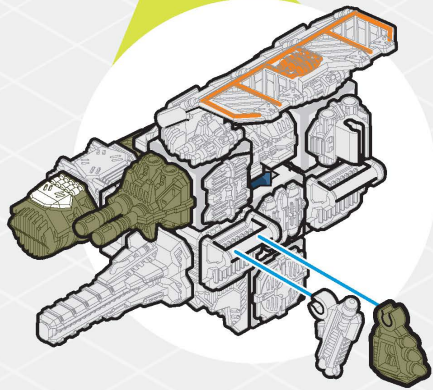
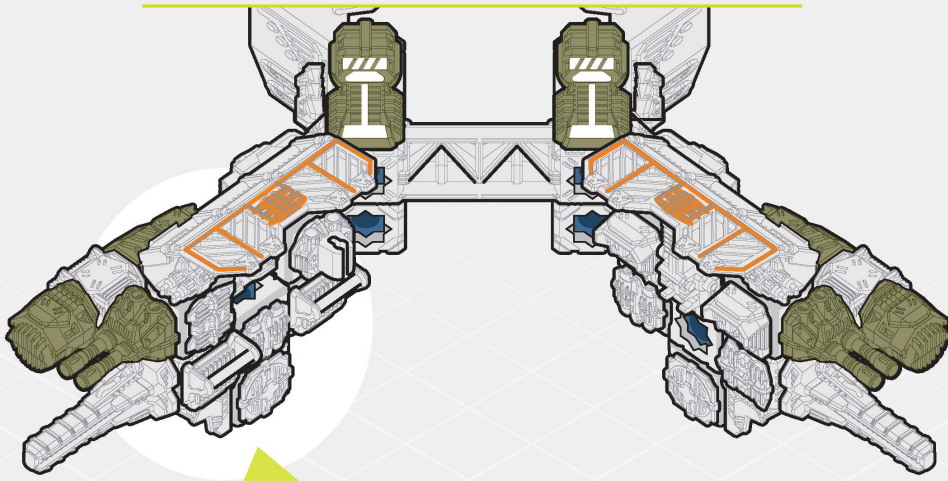
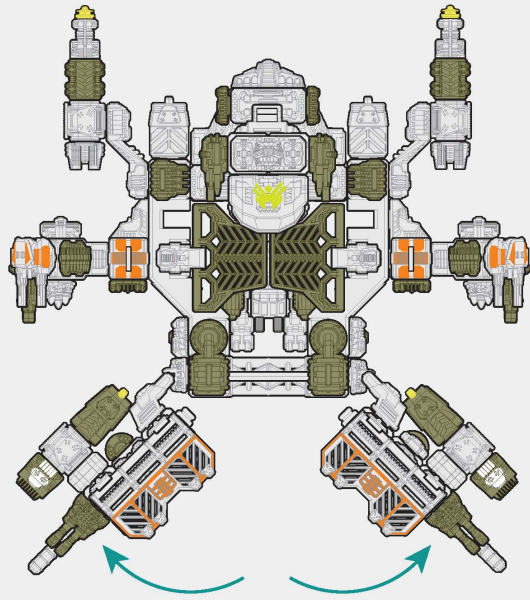



# 84

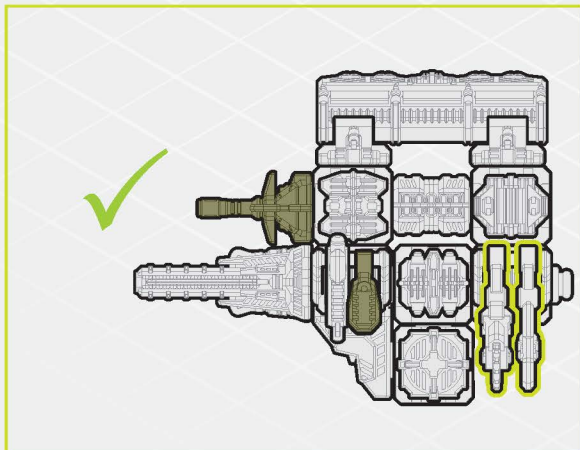
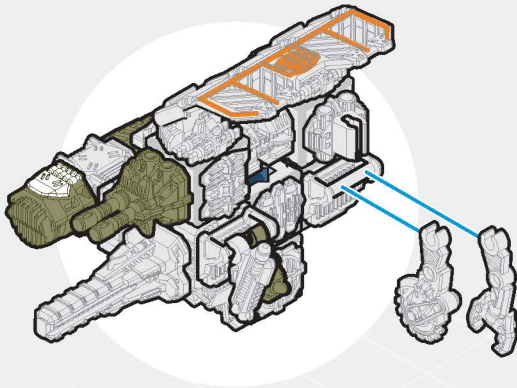
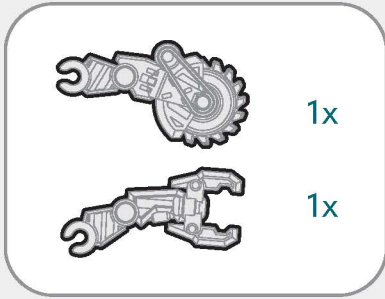

# 85

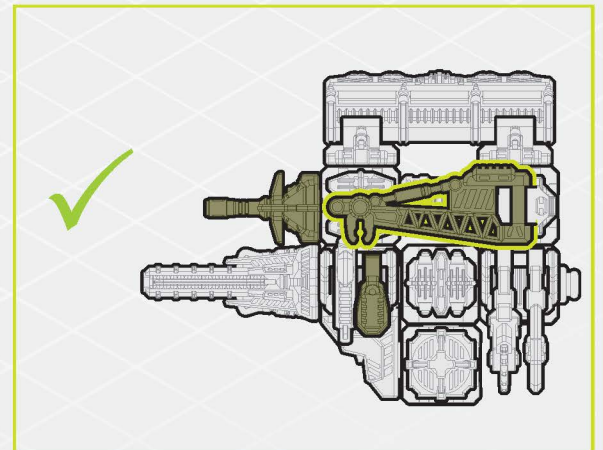
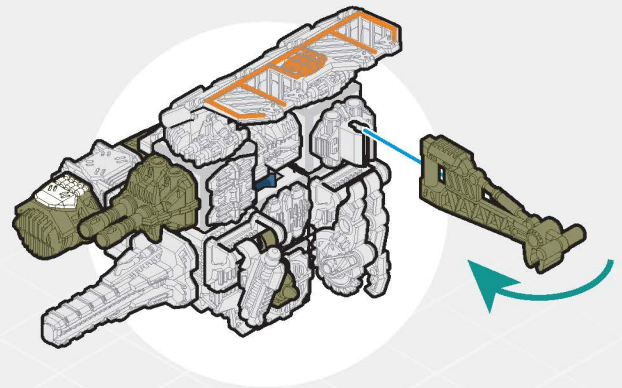
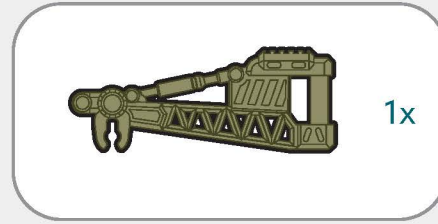

86

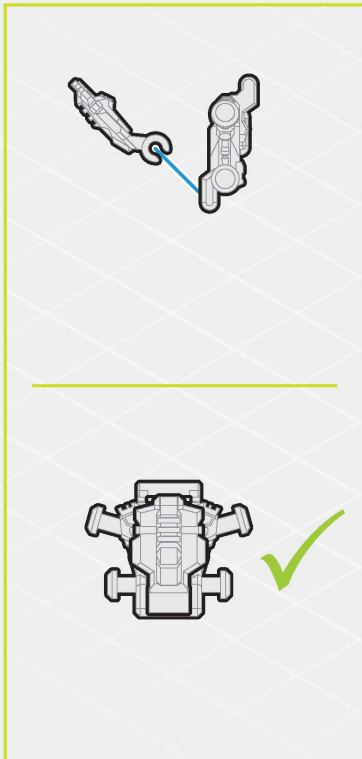
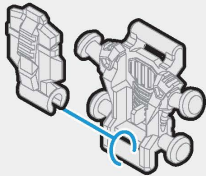
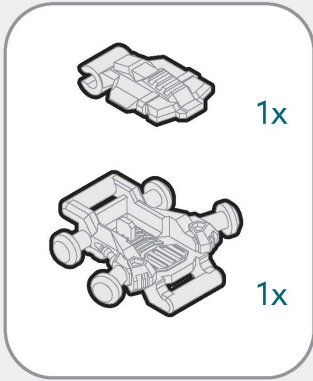

87

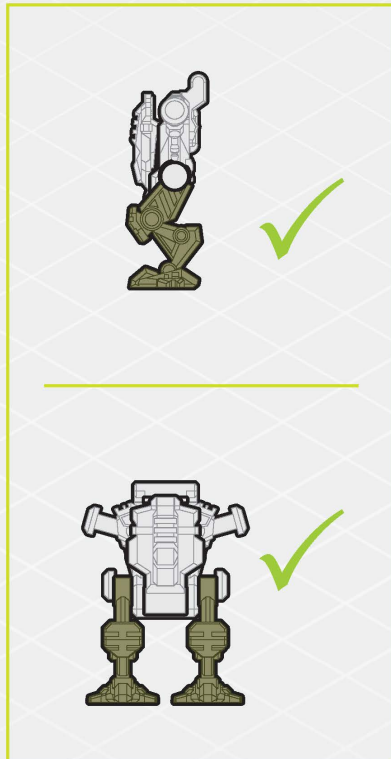
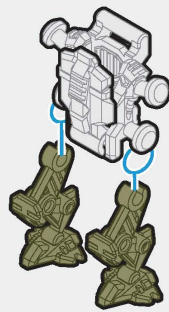

88

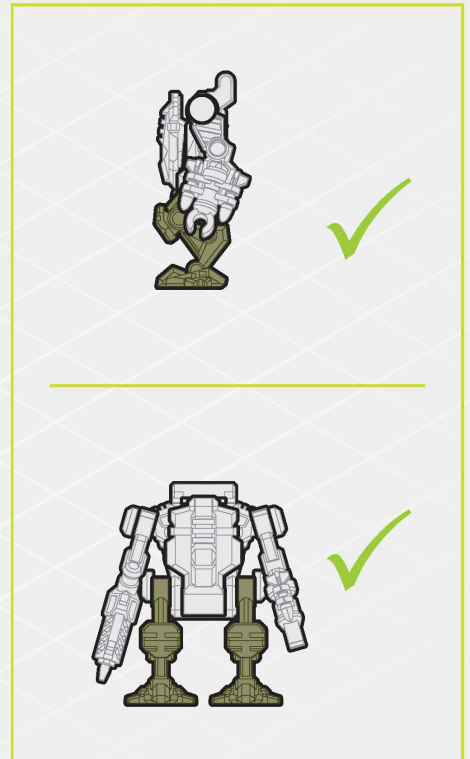
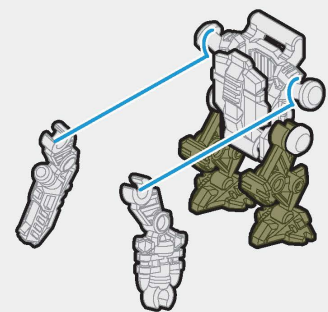
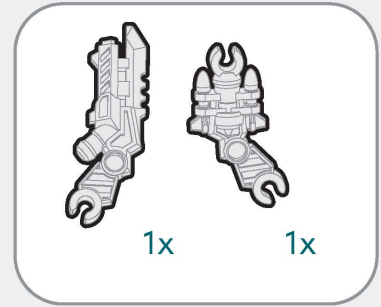



89

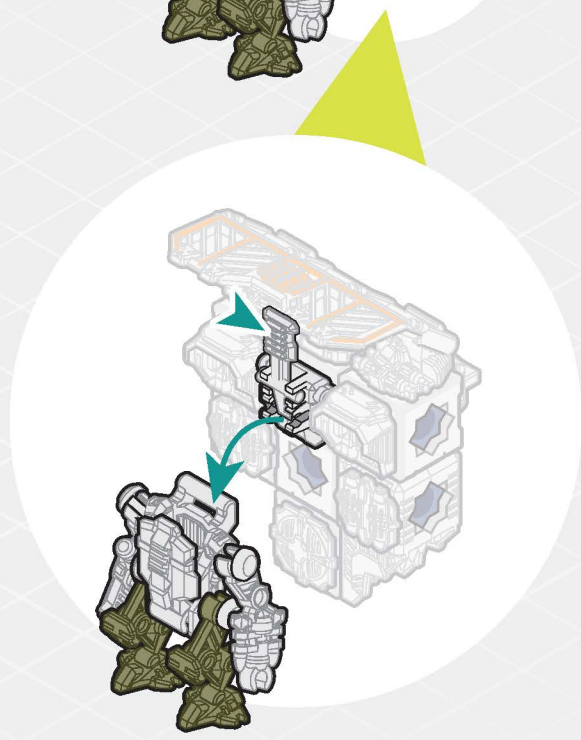
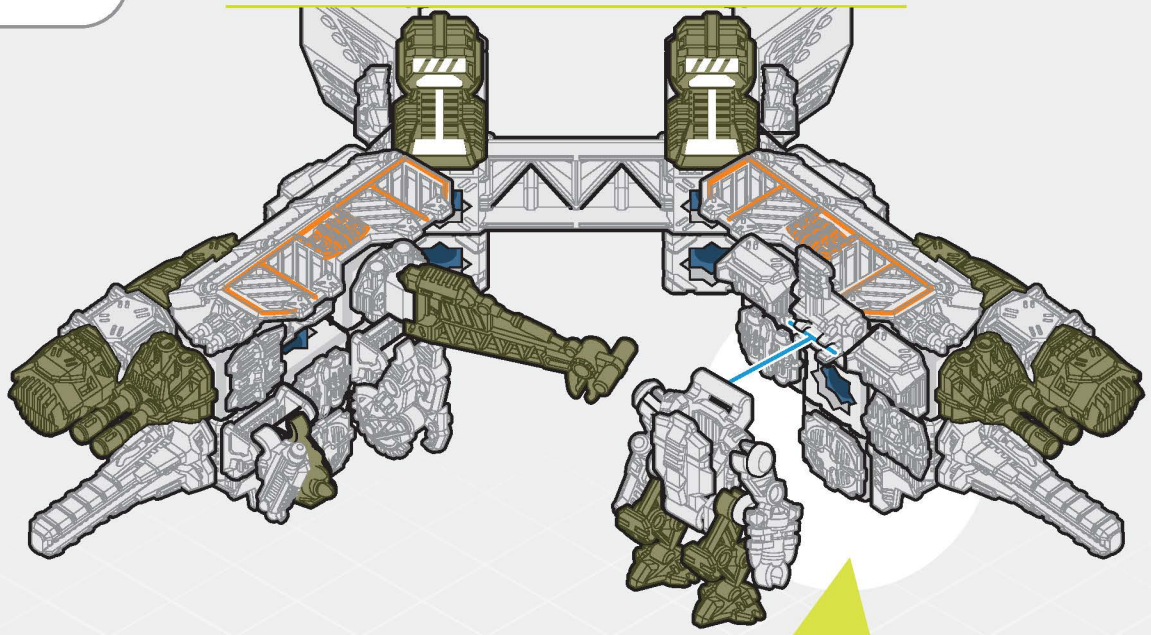
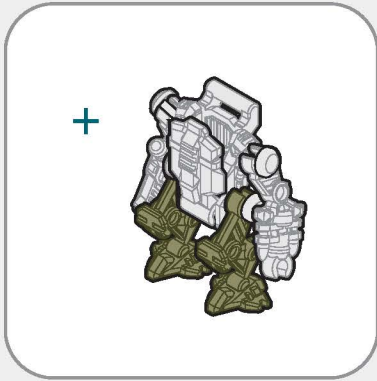

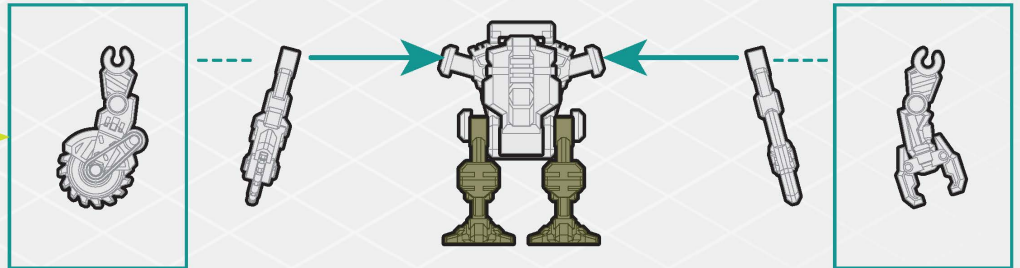
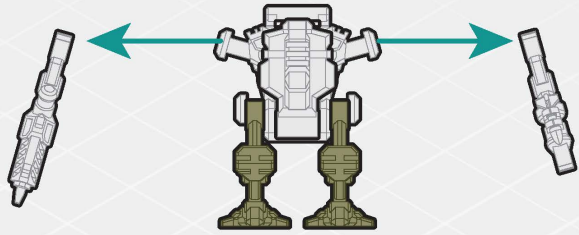
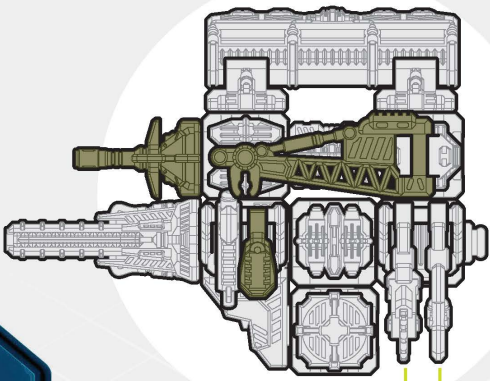
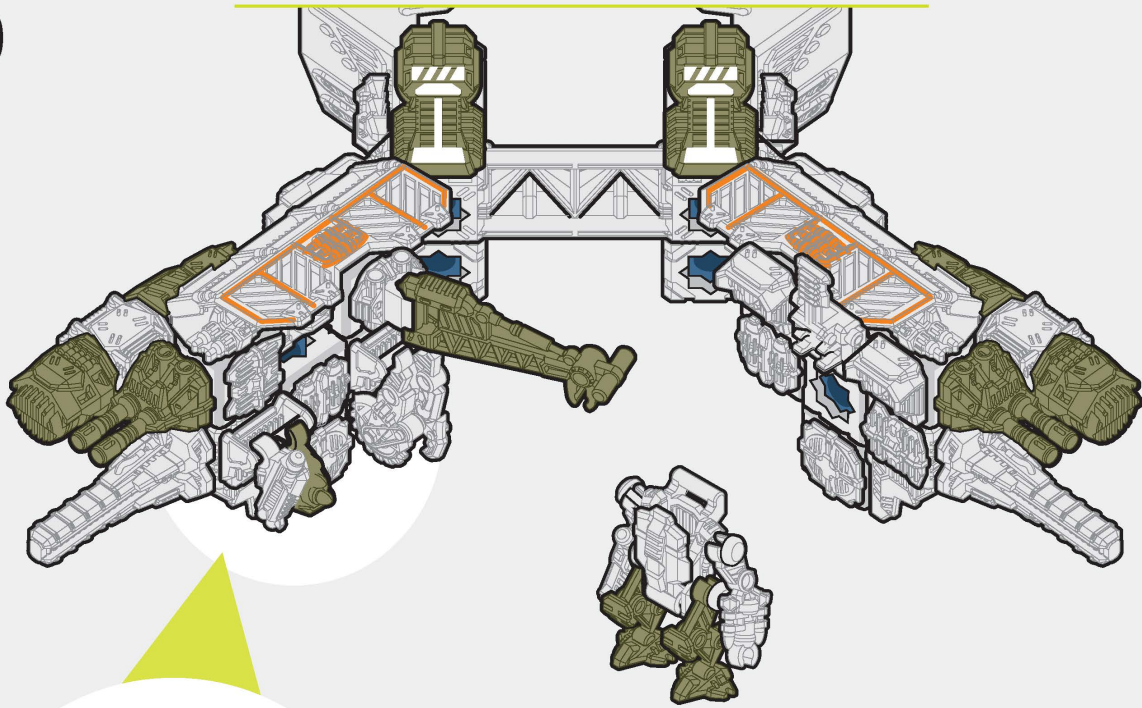



91

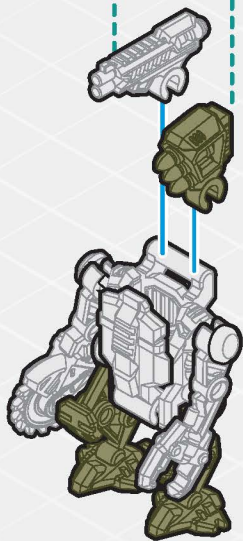
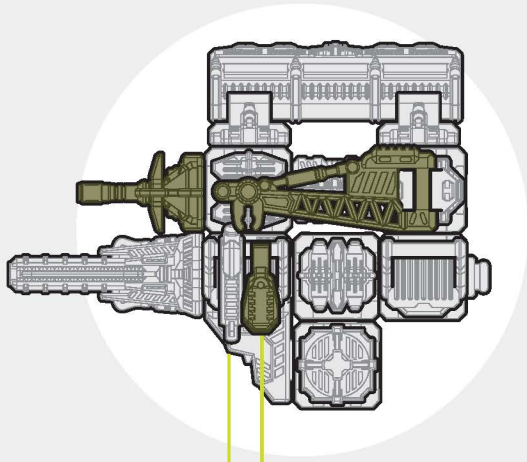

92

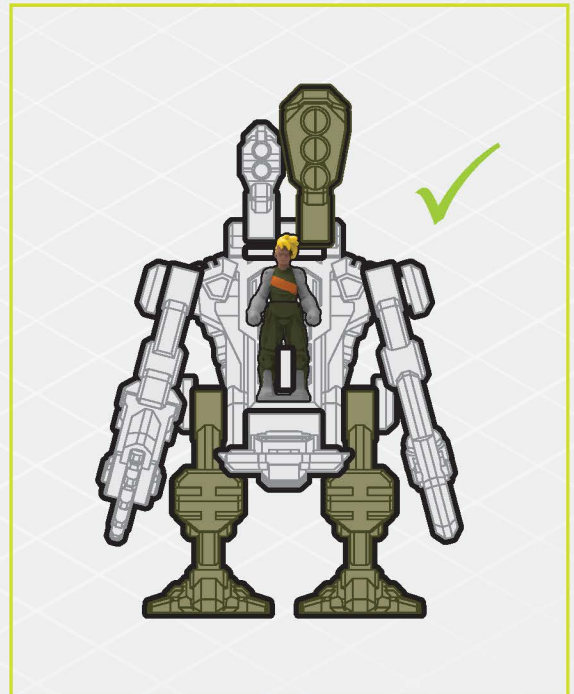
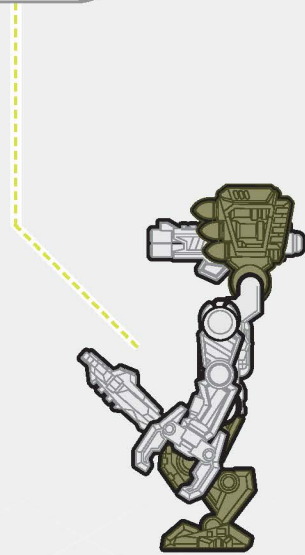

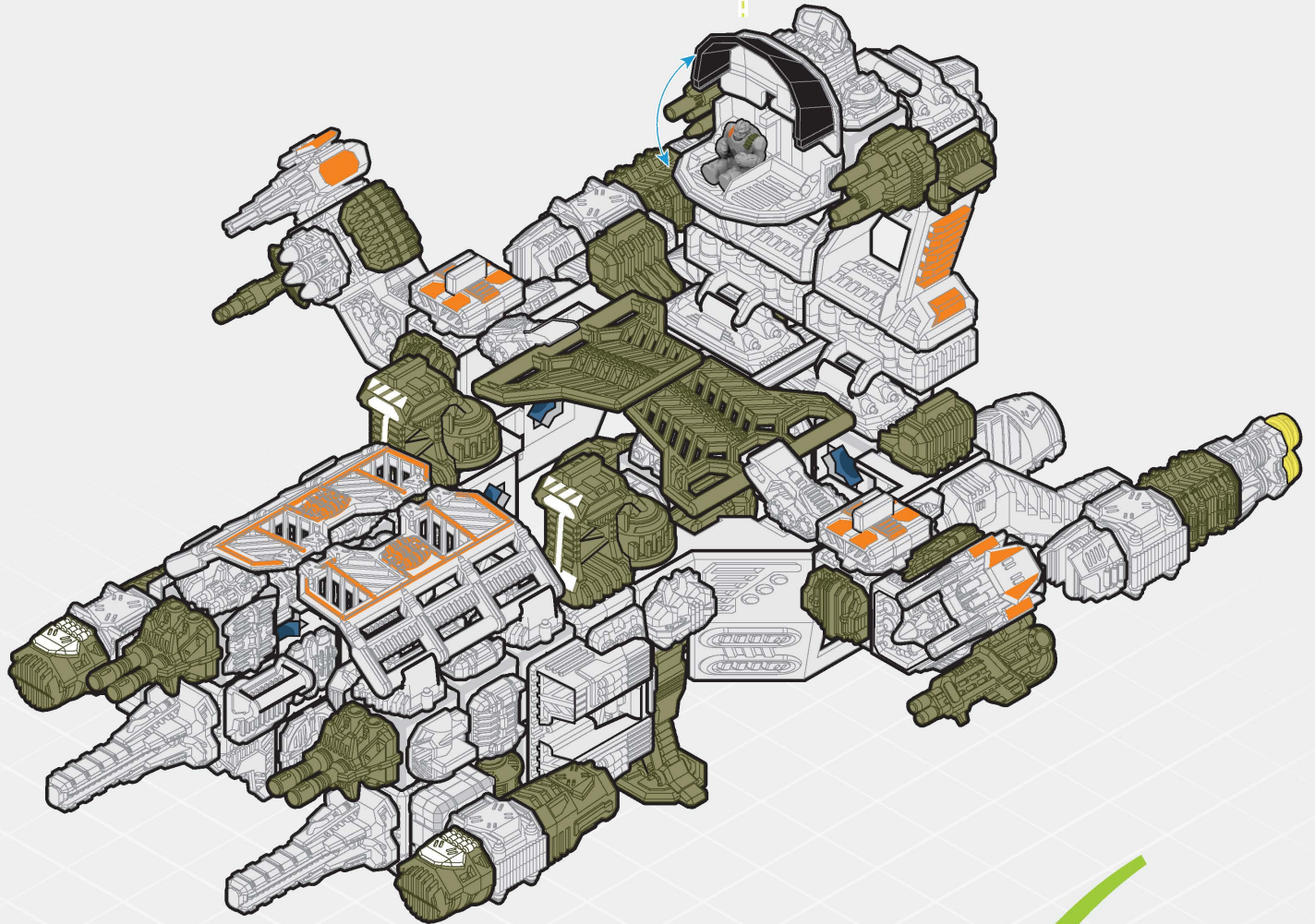



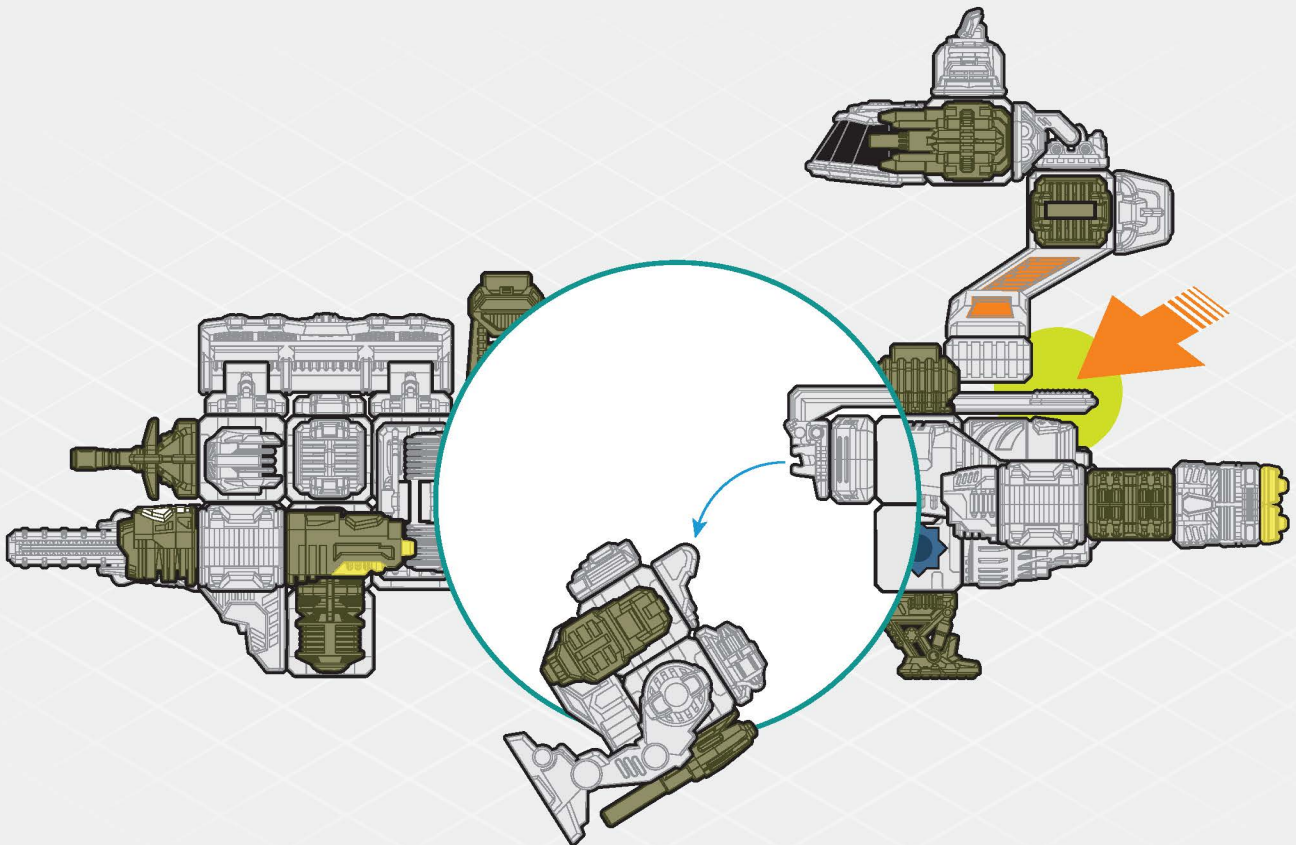
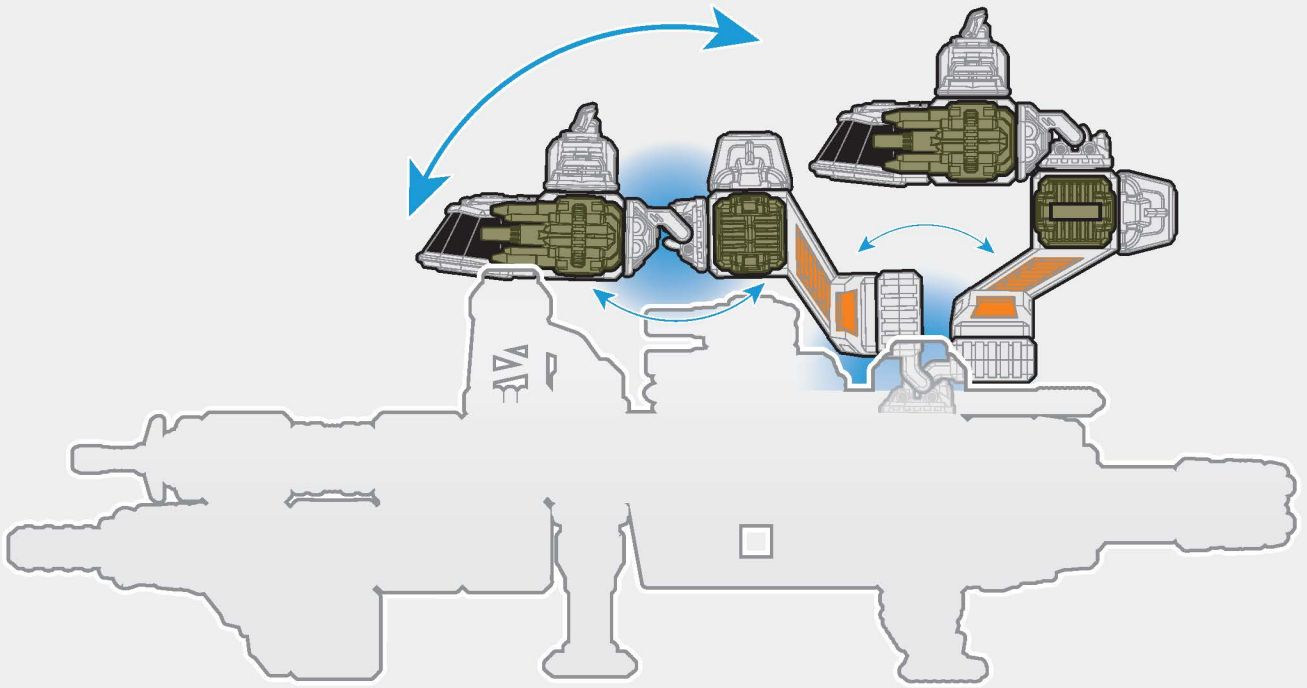

**Continue searching for the rest when you collect more Snap Ships!**

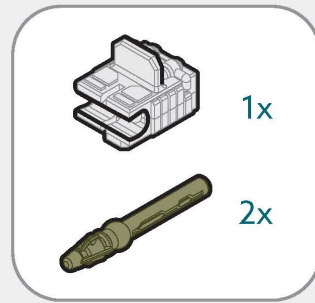
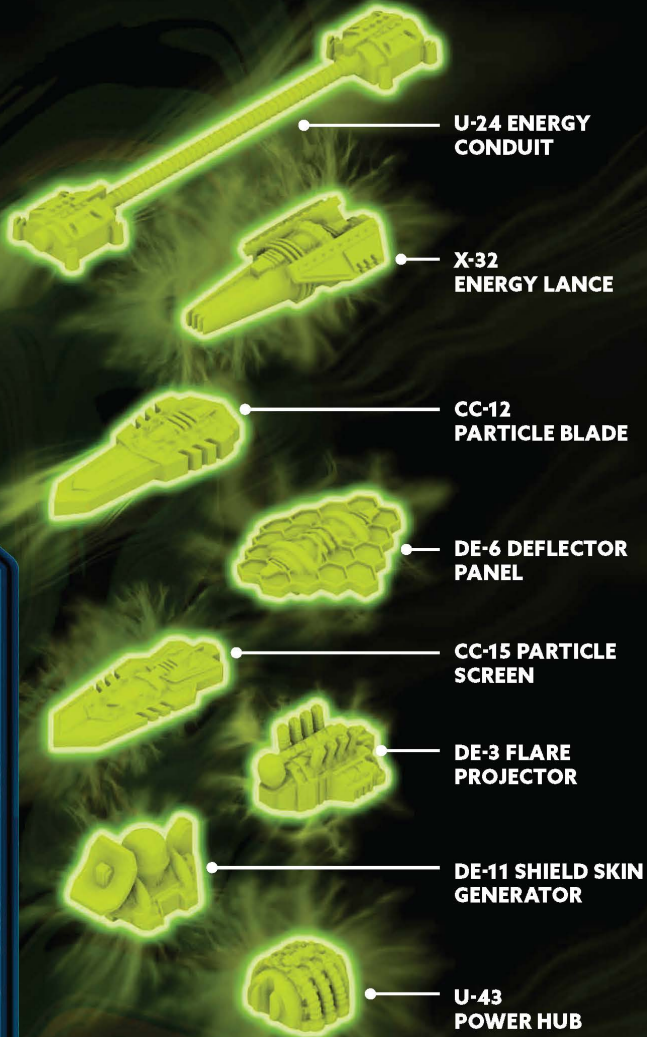

**⚠ WARNING:**  
EYE IMPACT HAZARD— Do not aim at eyes or face.

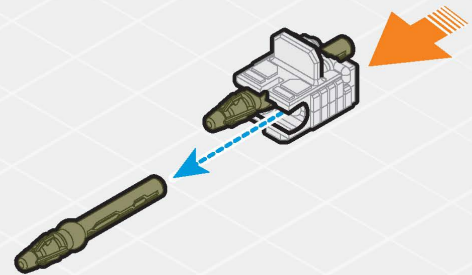
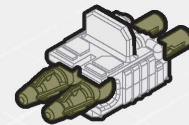
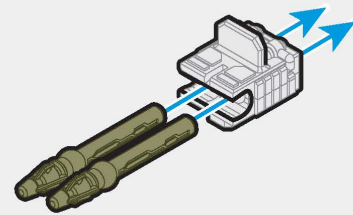



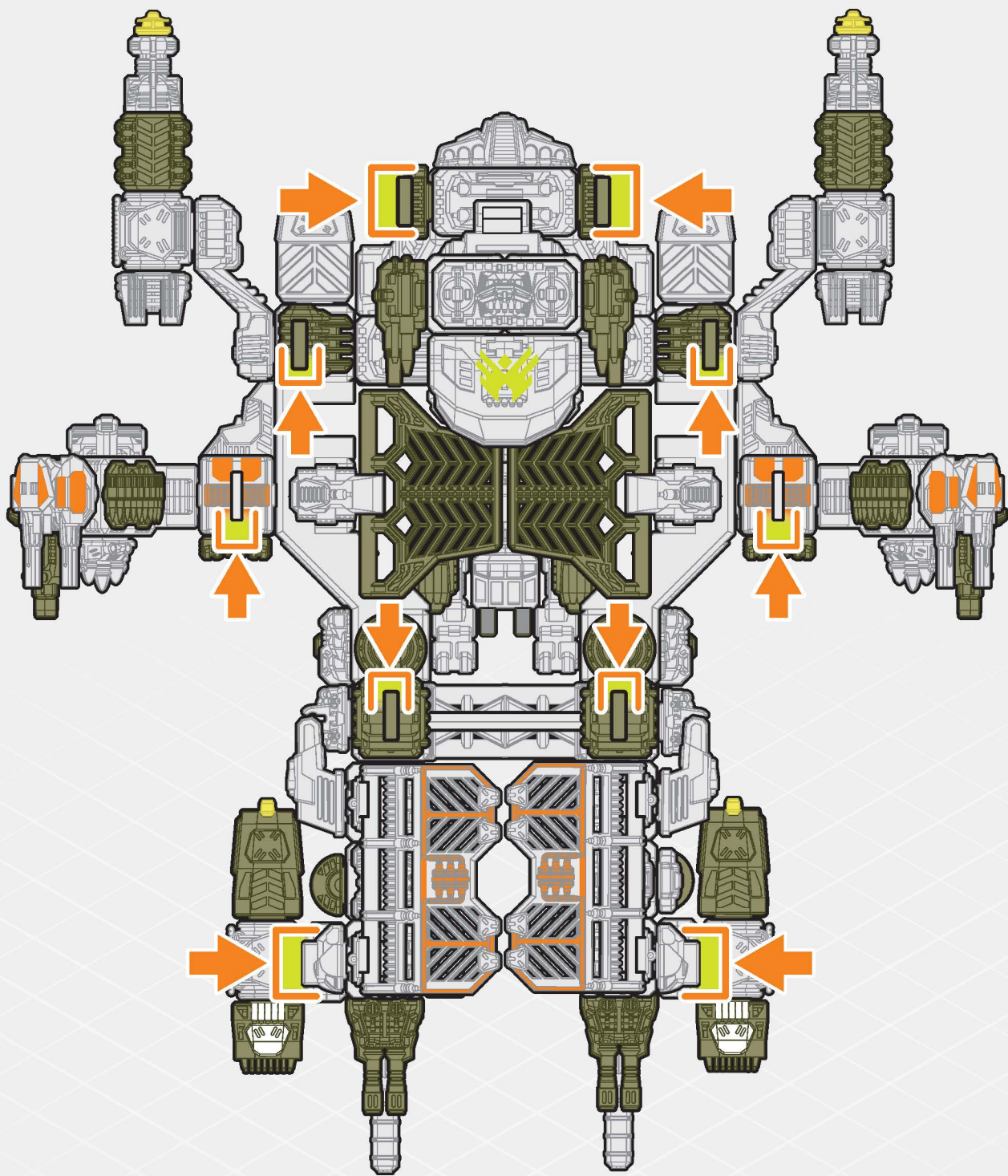

ACCESSORIES



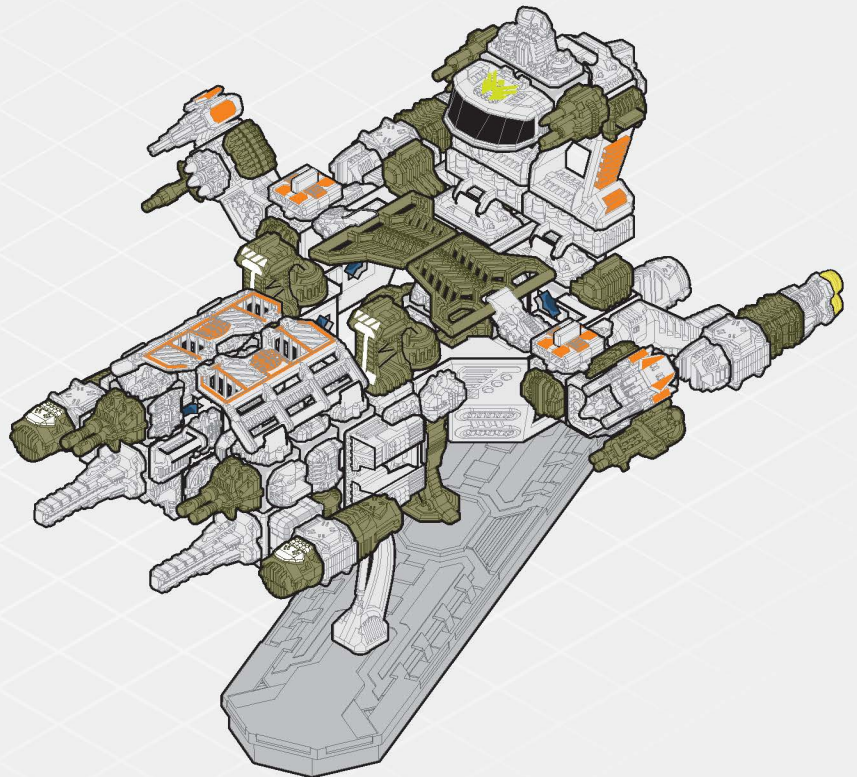
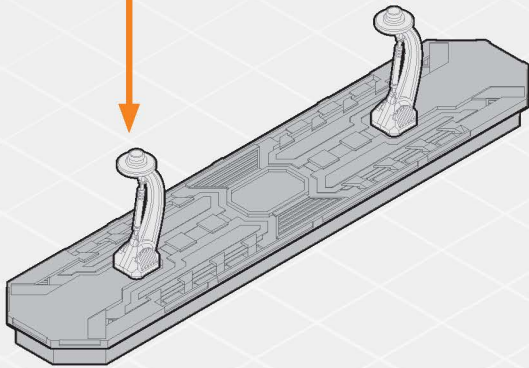
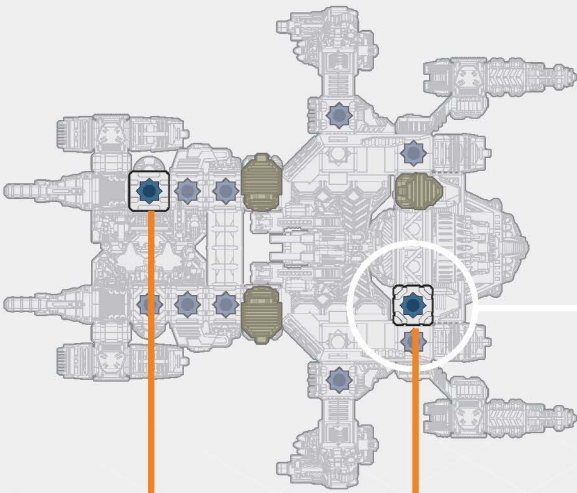
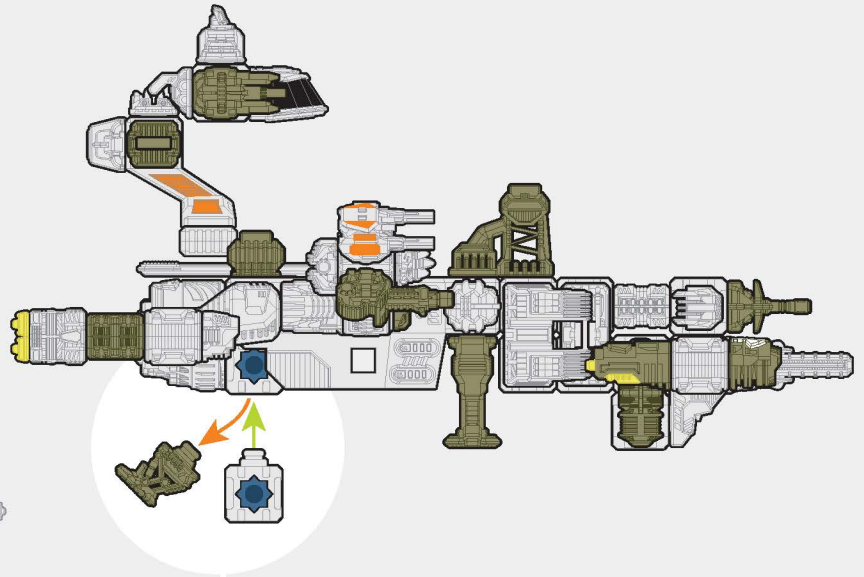
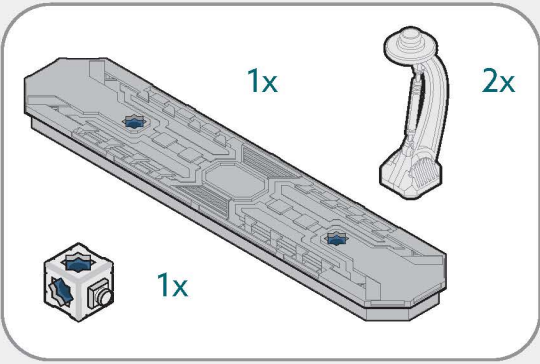



COMPONENTS





## COLLECT THEM ALL!



APP  
Ask a Parent First

Download the Snap Ships app for interactive builds and play



[www.snapships.com](http://www.snapships.com)

**Watch Action-Packed Videos!**

9527

Instructions can be downloaded at:  
[snapships.com](http://snapships.com)

If you have questions, please contact us.  
800-524-4263 \* Weekdays 8am to 5pm CST  
[playmonster.com/contact-us](http://playmonster.com/contact-us)

**PlayMonster.**



Copyright © 2021 PlayMonster LLC, 1400 E. Inman Pkwy., Beloit, WI 53511 USA.  
Made in China. All rights reserved. Snap Ships and Build to Battle are trademarks of Snap Ships, LLC. Snap Ships used under license. Copyright © 2021 Snap Ships, LLC. Parts and colors may vary from those shown. Invented by Scott Pease and Jeff Swenty.